

Data sheet | Item number: 2636-3104/020-000

PCB terminal block; 16 mm²; Pin spacing 10 mm; 4-pole; Push-in CAGE

CLAMP®; 16,00 mm²; gray

www.wago.com/2636-3104/020-000

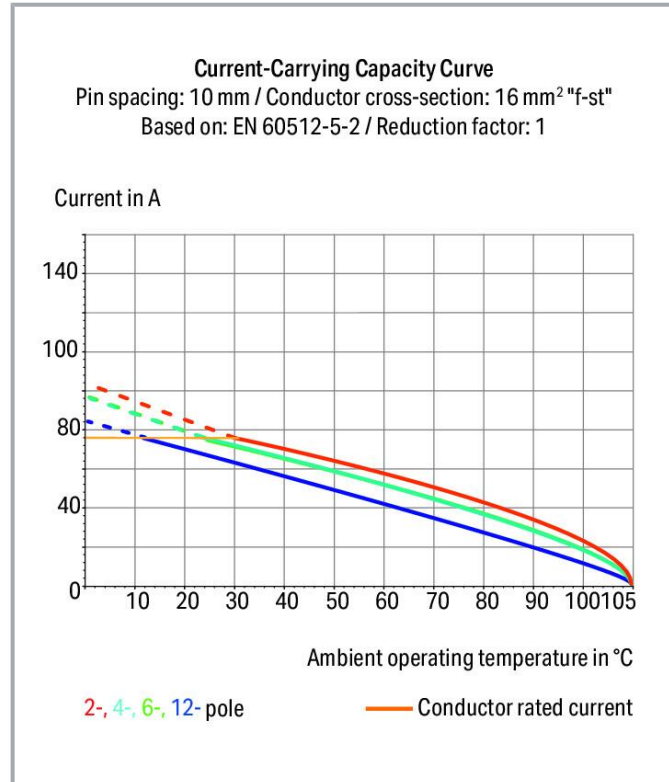

Subject to changes. Please also observe the further product documentation!

WAGO GmbH & Co. KG
Hansastr. 27
32423 Minden
Phone: +49571 887-0 | Fax: +49571 887-169
Email: info.de@wago.com | Web: www.wago.com

Do you have any questions about our products?
We are always happy to take your call at +49 (571) 887-44222.

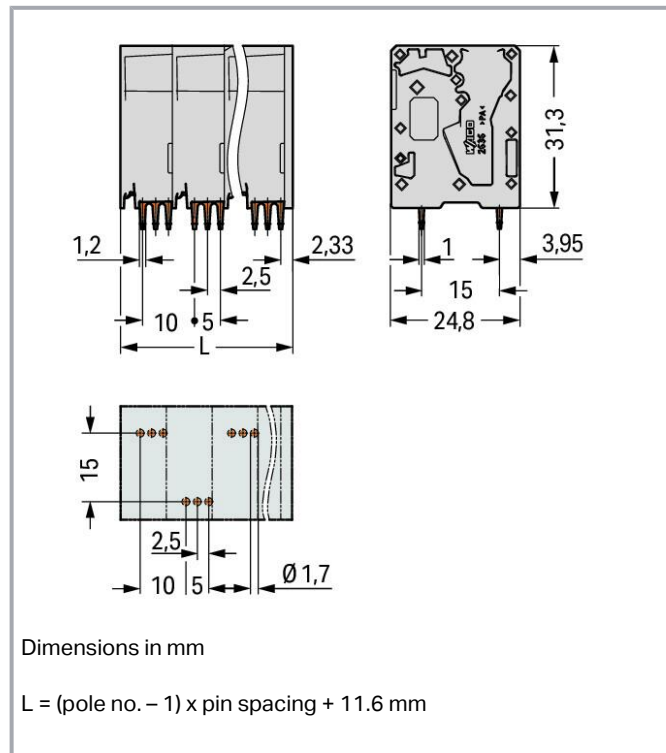
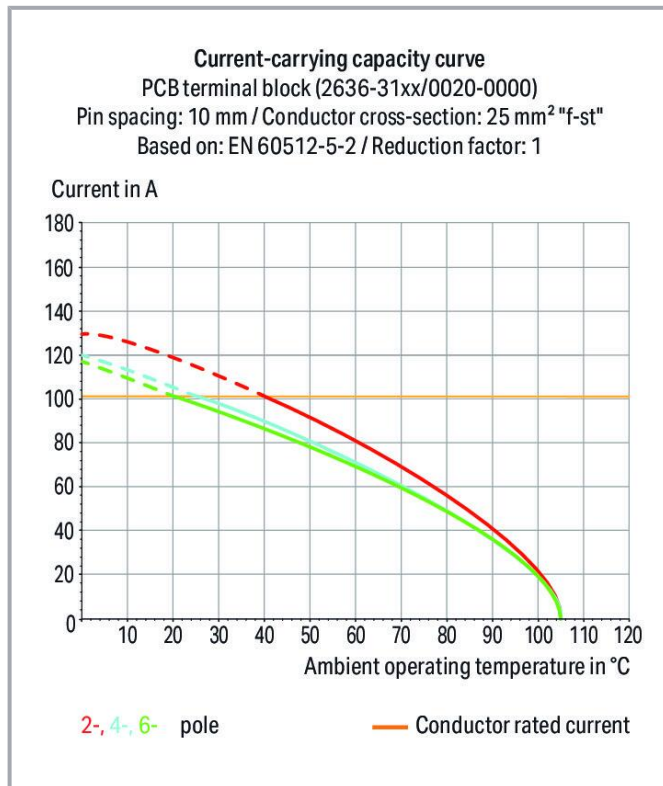

Item description

- PCB terminal strips with Push-in CAGE CLAMP® connection
- Push-in termination of solid and ferruled conductors
- Ideal for panel feedthrough applications via operation parallel to conductor entry
- Testing can be performed both parallel and perpendicular to conductor entry

Data

Notes

Variants:

- Other pole numbers
- Direct marking
- Other colors
- Other versions (or variants) can be requested from WAGO Sales or configured at <https://configurator.wago.com/>.

Electrical data

Subject to changes. Please also observe the further product documentation!



Ratings per IEC/EN

| | |
|-------------------------------|--|
| Ratings per | IEC/EN 60664-1 |
| Nominal voltage (III/3) | 1000 V |
| Rated impulse voltage (III/3) | 8 kV |
| Rated voltage (III/2) | 1000 V |
| Rated impulse voltage (III/2) | 8 kV |
| Nominal voltage (II/2) | 1000 V |
| Rated surge voltage (II/2) | 8 kV |
| Rated current | 76 A |
| Legend (ratings) | (III / 2) \triangleq Overvoltage category III / Pollution degree 2 |

Ratings per UL 1059

| | |
|--------------------------------|-------|
| Rated voltage UL (Use Group B) | 600 V |
| Rated current UL (Use Group B) | 66 A |
| Rated voltage UL (Use Group C) | 600 V |
| Rated current UL (Use Group C) | 66 A |

Ratings per CSA

| | |
|---------------------------------|-------|
| Approvals per | CSA |
| Rated voltage CSA (Use Group B) | 600 V |
| Rated current CSA (Use Group B) | 66 A |
| Rated voltage CSA (Use Group C) | 600 V |
| Rated current CSA (Use Group C) | 66 A |

Connection data

| | |
|----------------------------|---|
| Connection points | 4 |
| Total number of potentials | 4 |
| Number of connection types | 1 |
| Number of levels | 1 |

Connection 1

| | |
|-------------------------|--|
| Connection technology | Push-in CAGE CLAMP [®] |
| Actuation type | Operating tool |
| Solid conductor | 0.75 ... 16 mm ² / 18 ... 4 AWG |
| Fine-stranded conductor | 0.75 ... 25 mm ² / 18 ... 4 AWG |

Subject to changes. Please also observe the further product documentation!



| | |
|---|-------------------------------------|
| Fine-stranded conductor; with insulated ferrule | 0.75 ... 16 mm ² |
| Fine-stranded conductor; with uninsulated ferrule | 0.75 ... 16 mm ² |
| Fine-stranded conductor; with twin ferrule | 0.75 ... 6 mm ² |
| Strip length | 18 ... 20 mm / 0.71 ... 0.79 inches |
| Conductor connection direction to PCB | 90 ° |
| Pole number | 4 |

Physical data

| | |
|--------------------------------------|--------------------------|
| Pin spacing | 10 mm / 0.394 inches |
| Width | 41.6 mm / 1.638 inches |
| Height | 35.3 mm / 1.39 inches |
| Height from the surface | 31.3 mm / 1.232 inches |
| Depth | 24.8 mm / 0.976 inches |
| Solder pin length | 4 mm |
| Solder pin dimensions | 1.2 x 1 mm |
| Drilled hole diameter with tolerance | 1.7 ^(+0.1) mm |

Mechanical Data

| | |
|---------------|-----------------------|
| Mounting type | Feed-through mounting |
|---------------|-----------------------|

PCB contact

| | |
|-------------------------------------|--|
| PCB contact | THT |
| Solder pin arrangement | over the entire terminal strip (staggered) |
| Number of solder pins per potential | 3 |

Material Data

| | |
|-----------------------------|--|
| Note (material data) | Information on material specifications can be found here |
| Color | gray |
| Material group | I |
| Insulation material | Polyamide (PA66) |
| Flammability class per UL94 | V0 |
| Clamping spring material | Chrome-nickel spring steel (CrNi) |
| Contact material | Electrolytic copper (E _{Cu}) |
| Contact plating | Tin |

Subject to changes. Please also observe the further product documentation!

| | |
|--------|--------|
| Weight | 32.6 g |
|--------|--------|

Environmental requirements

| | |
|----------------------------------|-----------------|
| Limit temperature range | -60 ... +105 °C |
| Processing temperature | -35 ... +60 °C |
| Continuous operating temperature | -60 ... +105 °C |

Commercial data



| | |
|-----------------------|---------------|
| eCl@ss 10.0 | 27-44-04-01 |
| eCl@ss 9.0 | 27-44-04-01 |
| ETIM 8.0 | EC002643 |
| ETIM 7.0 | EC002643 |
| PU (SPU) | 25 pcs |
| Packaging type | box |
| Country of origin | DE |
| GTIN | 4055143625555 |
| Customs tariff number | 85369010000 |

Environmental Product Compliance

| | |
|------------------------|-------------------------|
| RoHS Compliance Status | Compliant, No Exemption |
|------------------------|-------------------------|

Approvals / Certificates

General approvals

| Logo | Approval | Additional Approval Text | Certificate name |
|--|--|--------------------------|------------------|
| | CB DEKRA Certification B.V. | EN 60947-7-4 | NL-61617 |
|  | CSA DEKRA Certification B.V. | C22.2 | 70154737 |
|  | cURus Underwriters Laboratories Inc. | C22.2 No. 158 | E45172 |
|  | KEMA/KEUR DEKRA Certification B.V. | EN 60947-7-4 | 71- 110774 |





Subject to changes. Please also observe the further product documentation!

WAGO GmbH & Co. KG
 Hansastr. 27
 32423 Minden
 Phone: +49571 887-0 | Fax: +49571 887-169
 Email: info.de@wago.com | Web: www.wago.com

Do you have any questions about our products?
 We are always happy to take your call at +49 (571) 887-44222.

Optional accessories

Ferrule

| Ferrule | | |
|---|--|--|
|  | Item no.: 216-210 Ferrule; Sleeve for 16 mm ² / AWG 6; insulated; electro-tin plated; electrolytic copper; gastight crimped; acc. to DIN 46228, Part 4/09.90; blue | www.wago.com/216-210 |
|  | Item no.: 216-284 Ferrule; Sleeve for 1.5 mm ² / AWG 16; insulated; electro-tin plated; electrolytic copper; gastight crimped; acc. to DIN 46228, Part 4/09.90; black | www.wago.com/216-284 |
|  | Item no.: 216-286 Ferrule; Sleeve for 2.5 mm ² / AWG 14; insulated; electro-tin plated; electrolytic copper; gastight crimped; acc. to DIN 46228, Part 4/09.90; blue | www.wago.com/216-286 |
|  | Item no.: 216-287 Ferrule; Sleeve for 4 mm ² / AWG 12; insulated; electro-tin plated; electrolytic copper; gastight crimped; acc. to DIN 46228, Part 4/09.90; gray | www.wago.com/216-287 |
|  | Item no.: 216-288 Ferrule; Sleeve for 6 mm ² / AWG 10; insulated; electro-tin plated; electrolytic copper; gastight crimped; acc. to DIN 46228, Part 4/09.90; yellow | www.wago.com/216-288 |
|  | Item no.: 216-289 Ferrule; Sleeve for 10 mm ² / AWG 8; insulated; electro-tin plated; electrolytic copper; gastight crimped; acc. to DIN 46228, Part 4/09.90; red | www.wago.com/216-289 |

Tool

| Operating tool | | |
|--|--|--|
|  | Item no.: 210-721 Operating tool; Blade: 5.5 x 0.8 mm; with a partially insulated shaft; multicoloured | www.wago.com/210-721 |

Downloads

Documentation

Additional Information

| | | | |
|------------------------|------------|--------|----------|
| Technical Section | 2019 Apr 3 | pdf | Download |
| Technical explanations | | 2.0 MB | |

CAD/CAE-Data

CAD data

| | | |
|--------------------------------|-----|----------|
| 2D/3D Models 2636-3104/020-000 | URL | Download |
|--------------------------------|-----|----------|

Subject to changes. Please also observe the further product documentation!

WAGO GmbH & Co. KG
 Hansastr. 27
 32423 Minden
 Phone: +49571 887-0 | Fax: +49571 887-169
 Email: info.de@wago.com | Web: www.wago.com

Do you have any questions about our products?
 We are always happy to take your call at +49 (571) 887-44222.



PCB Design

Symbol and Footprint 2636-3104/020-000

[URL](#)

[Download](#)

CAX data for your PCB design, consisting of "schematic symbols and PCB footprints", allow easy integration of the WAGO component into your development environment.

Supported formats:

- Accel EDA 14 & 15
- Altium 6 to current version
- Cadence Allegro
- DesignSpark
- Eagle Libraries
- KiCad
- Mentor Graphics BoardStation
- Mentor Graphics Design Architect
- Mentor Graphics Design Expedition 99 and 2000
- OrCAD 9.X PCB and Capture
- PADS PowerPCB 3, 3.5, 4.X, and 5.X
- PADS PowerPCB and PowerLogic 3.0
- PCAD 2000, 2001, 2002, 2004, and 2006
- Pulsonix 8.5 or newer
- STL
- 3D STEP
- TARGET 3001!
- View Logic ViewDraw
- Quadcept
- Zuken CadStar 3 and 4
- Zuken CR-5000 and CR-8000

PCB Component Libraries (EDA), PCB CAD Library Ultra Librarian

CAE data

ZUKEN Portal 2636-3104/020-000

[URL](#)

[Download](#)

Environmental Product Compliance

Compliance Search

Environmental Product Compliance 2636-3104/020-000

Subject to changes. Please also observe the further product documentation!

WAGO GmbH & Co. KG

Hansastr. 27

32423 Minden

Phone: +49571 887-0 | Fax: +49571 887-169

Email: info.de@wago.com | Web: www.wago.com

Do you have any questions about our products?

We are always happy to take your call at +49 (571) 887-44222.

PCB terminal block; 16 mm²; Pin spacing 10 mm; 4-pole; Push-in CAGE CLAMP®; 16,00 mm²; gray

Installation Notes

Conductor termination

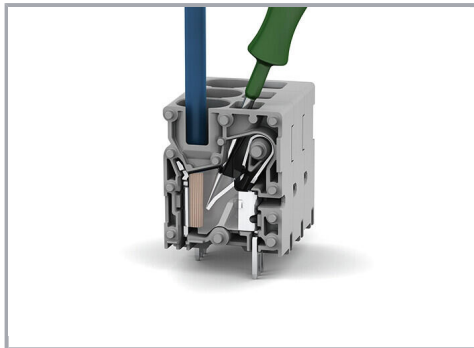

Insert fine-stranded conductors and remove all conductor types via operating tool.

Conductor termination

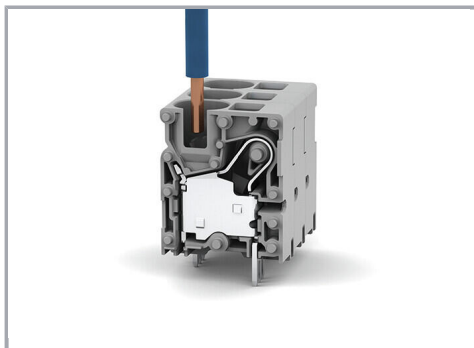

Insert solid conductors via push-in termination.

Subject to changes. Please also observe the further product documentation!