

183NQ080/R-1 183NQ100/R-1 SCHOTTKY RECTIFIER

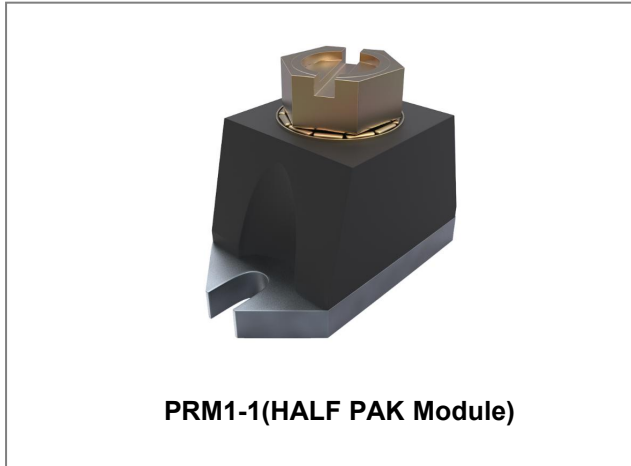

Features

- 175°C T_J operation
- Unique high power, Half-Pak module
- Replaces three parallel DO-5' S
- Easier to mount and lower profile than DO-5' S
- High purity, high temperature epoxy encapsulation for enhanced
- mechanical strength and moisture resistance
- Low forward voltage drop
- High frequency operation
- Guard ring for enhanced ruggedness and long term reliability
- Baseplate: Nickel plated; Terminals: Nickel plated
- This is a Pb – Free Device
- All SMC parts are traceable to the wafer lot
- Additional testing can be offered upon request

Circuit Diagram

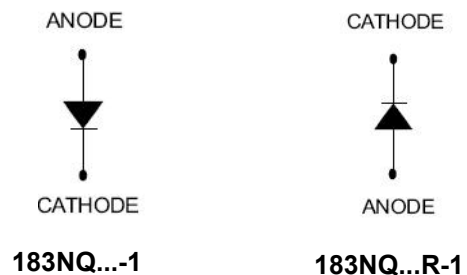

Applications

- Switching power supply
- Converters
- Free-Wheeling diodes
- Reverse battery protection

Maximum Ratings:

Characteristics	Symbol	Condition	Max.		Units
Peak Repetitive Reverse Voltage	V _{RRM}	-	80	183NQ080-1	V
Working Peak Reverse Voltage	V _{RWM}		100	183NQ100-1	
DC Blocking Voltage	V _R				
Average Forward Current	I _{F(AV)}	50% duty cycle @T _C =116°C, rectangular wave form	180		A
Peak One Cycle Non-Repetitive Surge Current	I _{FSM}	8.3 ms, half Sine pulse	1860		A
Non-Repetitive Avalanche Energy	E _{AS}	T _J =25°C, I _{AS} =0.50A, L=60mH	15		mJ
Repetitive Avalanche Current	I _{AR}	Current decaying linearly to zero in 1 µsec Frequency limited by T _J max. V _A =1.5×V _R typical	1		A

Electrical Characteristics:

Characteristics	Symbol	Condition	Typ.	Max.	Units
Forward Voltage Drop*	V_{F1}	@ 180A, Pulse, $T_J = 25\text{ }^\circ\text{C}$ @ 360A, Pulse, $T_J = 25\text{ }^\circ\text{C}$	0.79 -	0.91 1.14	V
	V_{F2}	@ 180A, Pulse, $T_J = 125\text{ }^\circ\text{C}$ @ 360A, Pulse, $T_J = 125\text{ }^\circ\text{C}$	0.61 -	0.73 0.89	V
Reverse Current*	I_{R1}	@ $V_R = \text{rated } V_R$, $T_J = 25\text{ }^\circ\text{C}$	0.002	4.5	mA
	I_{R2}	@ $V_R = \text{rated } V_R$, $T_J = 125\text{ }^\circ\text{C}$	1	60	mA
Junction Capacitance	C_T	@ $V_R = 5\text{V}$, $T_C = 25\text{ }^\circ\text{C}$ $f_{\text{SIG}} = 1\text{MHz}$	3500	4150	pF
Voltage Rate of Change	dv/dt	-	-	10,000	V/ μs

* Pulse width < 300 μs , duty cycle < 2%

Thermal-Mechanical Specifications:

Characteristics	Symbol	Condition	Specification		Units
Junction Temperature	T_J	-	-55 to +175		$^\circ\text{C}$
Storage Temperature	T_{stg}	-	-55 to +175		$^\circ\text{C}$
Typical Thermal Resistance Junction to Case	$R_{\theta\text{JC}}$	DC operation	0.30		$^\circ\text{C/W}$
Typical Thermal Resistance, case to Heat Sink	$R_{\theta\text{CS}}$	Mounting surface, smooth and greased	0.15		$^\circ\text{C/W}$
Mounting Torque	T_M	Non-lubricated threads	Mounting Torque	23(min) 29(max)	Kg-cm
			Terminal Torque	35(min) 46(max)	
Approximate Weight	wt	-	25.6		g
Case Style	PRM1-1				

Ratings and Characteristics Curves

Typical Forward Characteristics

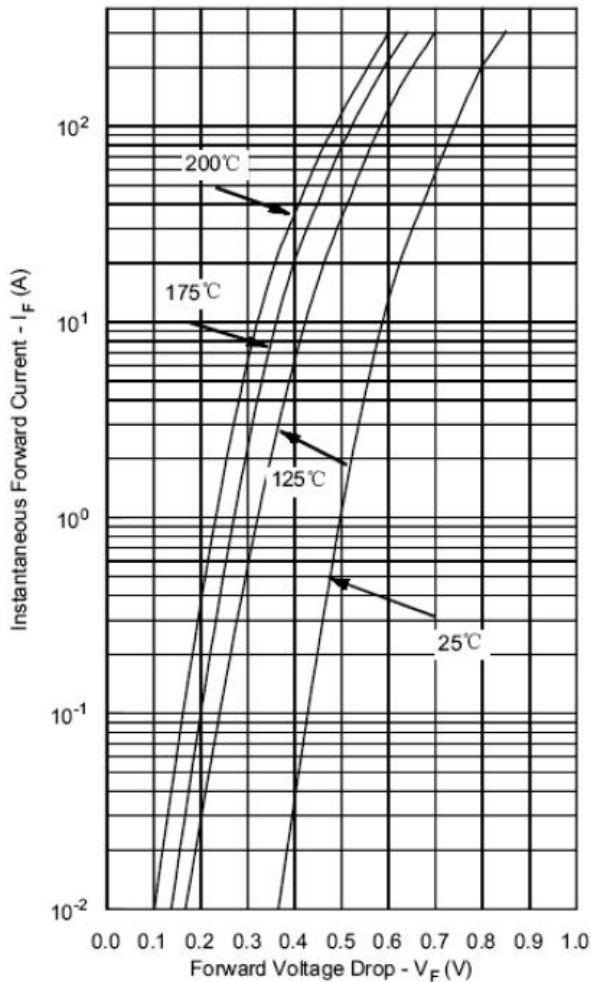

Typical Reverse Characteristics

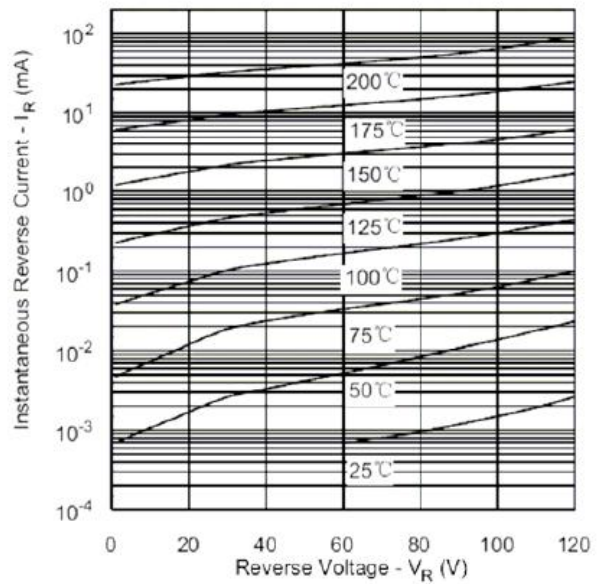

Typical Junction Capacitance

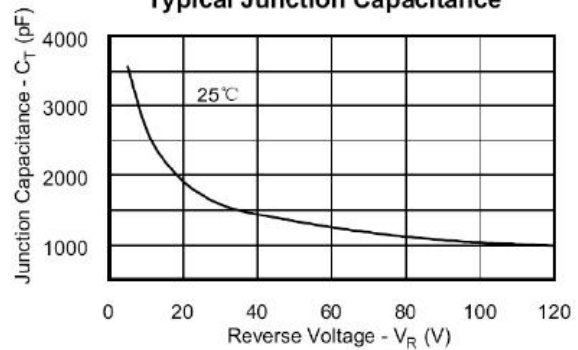

Ordering Information

Device	Package	Shipping
183NQ SERIES	PRM1-1(Pb-Free)	27pcs/ box

For information on tape and reel specifications, including part orientation and tape sizes, please refer to our tape and reel packaging specification.

Marking Diagram

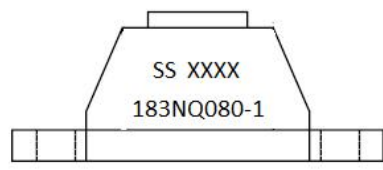

Where XXXX is YYWW

1st row SS YYWW
2nd row 183NQ080-1
SS = SS
YY = Year
WW = Week

Cautions: Molding resin
Epoxy resin UL:94V-0

Mechanical Dimensions PRM1-1 (Inches/Millimeters)

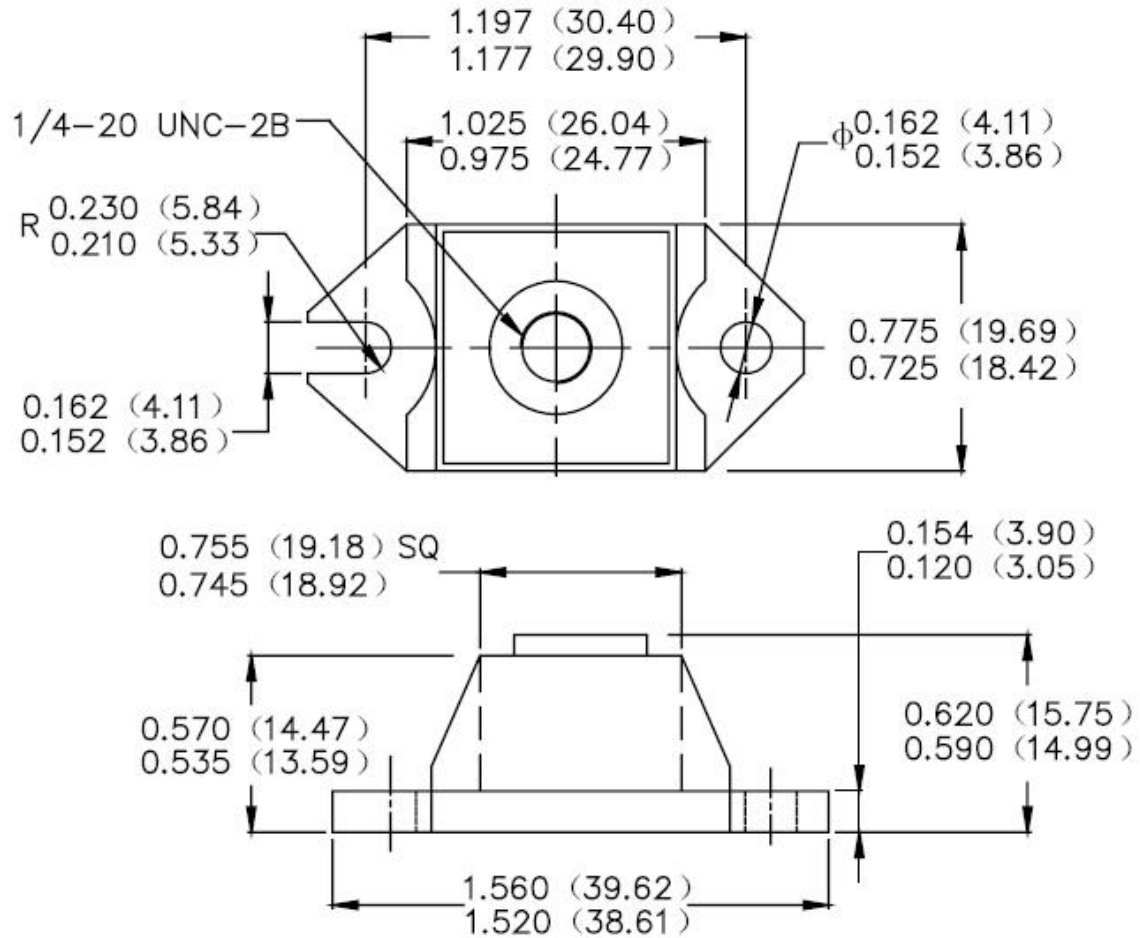

Technical Data
Data Sheet N1174, Rev. A



DISCLAIMER:

- 1- The information given herein, including the specifications and dimensions, is subject to change without prior notice to improve product characteristics. Before ordering, purchasers are advised to contact the SMC Diode Solutions sales department for the latest version of the datasheet(s).
- 2- In cases where extremely high reliability is required (such as use in nuclear power control, aerospace and aviation, traffic equipment, medical equipment, and safety equipment), safety should be ensured by using semiconductor devices that feature assured safety or by means of users' fail-safe precautions or other arrangement.
- 3- In no event shall SMC Diode Solutions be liable for any damages that may result from an accident or any other cause during operation of the user's units according to the datasheet(s). SMC Diode Solution assumes no responsibility for any intellectual property claims or any other problems that may result from applications of information, products or circuits described in the datasheets.
- 4- In no event shall SMC Diode Solutions be liable for any failure in a semiconductor device or any secondary damage resulting from use at a value exceeding the absolute maximum rating.
- 5- No license is granted by the datasheet(s) under any patents or other rights of any third party or SMC Diode Solutions.
- 6- The datasheet(s) may not be reproduced or duplicated, in any form, in whole or part, without the expressed written permission of SMC Diode Solutions.
- 7- The products (technologies) described in the datasheet(s) are not to be provided to any party whose purpose in their application will hinder maintenance of international peace and safety nor are they to be applied to that purpose by their direct purchasers or any third party. When exporting these products (technologies), the necessary procedures are to be taken in accordance with related laws and regulations..