

ToughSonic[®] **General Purpose Series**

Ultrasonic Distance Sensors
PC Configurable and/or Push-Button Teachable

Installation and Operating Instructions for



ToughSonic 3

TSPC-30S2, TSPC-N1S2



ToughSonic 12

TSPC-30S1K, TSPC-N1S1K



ToughSonic 14

TSPC-30S1, TSPC-N1S1



ToughSonic 30

TSPC-15S



ToughSonic 50

TSPC-21S

TSPC-21SR

TSPC-25P

Product Declarations

Document Revisions

Initial Release	31 May 2015
General corrections	8 Apr 2016
General corrections	9 Nov 2016
New products added	19 Aug 2019
New products added	1 July 2020

Related Products

SenixVIEW for Windows

A setup tool for ToughSonic series sensors, this software installs on a PC and is used to configure sensor options, select and calibrate outputs, view and analyze measurements, and save the result to a PC hard drive. Recalled configurations can restore or duplicate an application without recalibration. View, chart, log, and analyze sensor operation. Sensor firmware upgrades can be done easily through SenixVIEW too. Download SenixVIEW at no charge from: <https://senix.com/senixview-ultrasonic-sensor-software/>

Setup Kits

Used for bench viewing or configuring sensors, kits include power supply, terminal board and cables to interconnect with your PC. A SenixVIEW thumb drive with software, videos and manuals is also included (see Software and Interconnection, page 15).

CE Compliance

ToughSonic® family of ultrasonic sensors are compliant with the CE Electromagnetic Compatibility Directives and Standards listed below:

Directives: Electromagnetic Compatibility (2004/108/EC)
Low-Voltage (2006/95/EC)
Standards: EMC: EN 61326-1:2006 Industrial
Safety: EN 61010-1:2001

Warranty

Senix makes no warranty, representation or guarantee regarding the suitability of the products for any particular purpose. All specifications are subject to change without notice.

Senix, Inc. will repair or replace, at our option, any part found by us to be defective in material or workmanship if the product is received by Senix, freight prepaid, within one year from the date of original shipment to buyer.

Disclaimer and Release. The warranties, obligations and liabilities of Senix and the remedies of buyer set forth above are exclusive and in substitution for, and buyer hereby waives, releases and renounces all other warranties, obligations and liabilities of Senix and all other rights, claim, and remedies of buyer against Senix, expressed or implied, arising by law or otherwise, including but not limited to: (A) Any implied warranty or merchantability or fitness; (B) Any implied warranty arising from course of performance, course of dealing or usage of trade; (C) Any obligation, liability, right, claim or remedy in tort, whether or not arising from the negligence of Senix (whether active, passive or imputed); and (D) Any obligation, liability, right, claim or remedy for loss or damage to any product.

Exclusion of Consequential and Other Damages. Senix shall have no obligation or liability, whether arising in contract (including warranty), tort (including active, passive or imputed negligence) or otherwise, for loss of use, revenue or profit with respect to any non-conformance or defect in any product delivered under this agreement, or for any other direct, incidental or consequential damages.

Governing Law. The terms and conditions of this agreement shall be governed by the domestic law of the State of Vermont, U.S.A.

Repairs and Returns

Any returns must have a Return Material Authorization (RMA) number.

Contact us at:

Mail: Senix Corporation
10516 Route 116 Suite 300
Hinesburg, VT 05461 USA

e-mail: customer.service@senix.com

web: www.senix.com

Table of Contents

PRODUCT DECLARATIONS.....	2
Document Revisions _____	2
Related Products _____	2
CE Compliance _____	2
Warranty _____	2
Repairs and Returns _____	2
Table of Contents _____	3
Terminology _____	4
ULTRASONICS OVERVIEW.....	5
Introduction _____	5
Advantages _____	5
Typical Applications _____	5
SENSOR OVERVIEW	6
ToughSonic Product Features _____	6
Startup Tips _____	7
Specifications _____	8
Mechanical Details _____	12
Mounting and Installation _____	12
Rear Features _____	15
Target Indicator _____	16
Output Status Indicators _____	17
INTERFACES.....	19
Wires Identification _____	19
ToughSonic 3, 12, & 14 Output Selection _____	20
Analog Outputs _____	21
Serial Data Interface _____	26
Serial Parameters _____	27
Serial Data Protocols _____	29
OPERATION.....	31
Power Up _____	31
Measurement Activation _____	31
Synchronization _____	33
Operating Range _____	34
Measurement Process _____	34
Sensor Viewing _____	35
Measurement Rate _____	37
Output Response Time _____	37
Filters _____	38
Time Delays _____	41
Temperature Compensation _____	41
SENIXVIEW SOFTWARE	43
Install SenixVIEW _____	43

Application Setups _____	43
Connect a Sensor _____	45
Outputs & Indicators _____	45
Sensor Adjustment _____	49

TEACH ADJUST..... 50

APPENDIX A – LIST OF ADJUSTABLE FEATURES 53

LIST OF FIGURES

Figure 1 - Part Number Structure	6
Figure 2 - Mechanical Drawing, ToughSonic 3, 12, 14 metric thread.....	12
Figure 3 - Mechanical Drawing, ToughSonic 30, 50, and 50P	12
Figure 4 - Sensor Orientation	12
Figure 5 - Mounting.....	13
Figure 6 - Sensor Rear Features.....	15
Figure 7 - Target Indicator Functions	16
Figure 8 - Output Status Indicator Operations	18
Figure 9 - RS-232 PC COM Port Connections	20
Figure 10 - Voltage Output Wiring	21
Figure 11 - Sourcing Current Loop Wiring	21
Figure 12 - Sinking Current Loop Wiring.....	21
Figure 13 - SenixVIEW Analog Adjustments	23
Figure 14 - Sinking Switch Output Wiring.....	23
Figure 15 - Sourcing Switch Output Wiring	24
Figure 16 - Switch Hysteresis & Window Modes	25
Figure 17 - SenixVIEW Switch Adjustment	25
Figure 18 - RS-232 PC COM Port Connections	26
Figure 19 - RS-232 Connections.....	26
Figure 20 - Serial-485 Connections.....	27
Figure 21 - RS-485 Network Wiring.....	27
Figure 22 - Measurement Activation Selections.....	32
Figure 23 - SenixVIEW Polling Controls	32
Figure 24 - SYNC Wiring	33
Figure 25 - SYNC Phases and Timing	33
Figure 26 - Measurement Process Diagram	34
Figure 27 - SenixVIEW Distance Displays.....	35
Figure 28 - Filters Block Diagram	39

LIST OF TABLES

Table 1 - Wire Assignments _____	19
Table 2 - Measurement Activation Summary _____	31
Table 3 - Maximum Range vs. Measure Rate _____	37
Table 4 - Filter Response Time _____	40
Table 5 - Pushbutton TEACH Features List _____	52

Terminology

Terms listed here are shown in *italics* throughout this document. An asterisk (*) indicates a SenixVIEW configurable parameter.

Analog An electrical output type that varies in proportion to measured distance. Analog output types can be either *current loop* or *voltage*.

Analog High Value* The maximum (highest) value of an *analog* output. For example, the Analog High Value for a 4-20 mA current loop analog output is 20 mA. Computer configurable models allow this value to be user-entered.

Analog Low Value* The minimum (lowest) value of an *analog* output. For example, the Analog Low Limit value for a 0-10 VDC *voltage output* is 0 volts. Computer configurable models allow this value to be user-entered.

Analog Window* A range of distances between two *endpoints*, within which the analog output will vary between the analog *low value* and analog *high value* proportional to measured distance.

Current Loop Output* An *analog* output type that drives an electrical current proportional to measured distance. ToughSonic sensors provide 4-20 mA or SenixVIEW customized output ranges in sourcing or sinking current..

Deadband The small distance near the sensor face within which distance cannot be measured. See also *Range MIN*.

Endpoint* One of two end distances representing the outer limits of the *analog window*.

Hysteresis* The distance between a switch's *Setpoint* and *OFF Distance*. It reverses direction about the *Setpoint* if the *Polarity* is reversed.

Ingress Rating An enclosure rating that identifies how susceptible a product is to the entry (ingress) of external objects or liquids.

Measurement Rate* The repetitive rate that the sensor measures distance (see *response time*).

Measurement Interval* The time between measurements [$1 / \text{Measurement Rate}$].

Measurement Process* The measurement, filtering and time delays that affect sensor outputs (p 34).

Maximum Range The maximum target detection distance of a sensor model; may be overridden by *Range MAX* (p 34).

Near MIN A distance extending 0.25 in. farther than *Range MIN* within which the Target Indicator will flash as a warning.

Operating Range* The range of distances between the *range MIN* and *range MAX* values (p 34).

Optimum Range The range of target distances recommended for optimum performance in varying environmental conditions.

Output Status Indicator An indicator at the rear of ToughSonic 3,12, and 14 that shows the status of an *analog*, *switch* or *serial data* output. There is a separate output status indicator for output #1 (black wire) and output #2 (white wire).

Polarity* The behavior of a *switch* output at its setpoint, defined as “on-closer” or “on farther”. A switch turns OFF in the reverse direction after the *Hysteresis* distance.

Range MAX* The farthest distance of the Operating Range; user adjustable in SenixVIEW.

Range MIN* The nearest distance of the Operating Range; a target is not detected closer than the greater of *Range MIN* or the *Deadband*.

RS-232* An electrical interface standard used to transfer information using *serial data* communications. This is a single ended interface with a specified maximum range of 50 feet (15 meters) that typically supports one device.

RS-485* An electrical interface standard used to transfer information using *serial data* communications. This is a long distance differential interface capable of supporting multiple addressable devices.

Response Time* The time required for sensor outputs to respond to measurements; affected by *measurement rate* and filter selections.

Serial Data Distance data output over the serial interface as opposed to the analog or switch lines

Setpoint* The distance a *switch* output turns ON. (see also *OFF distance*, *polarity* and *Hysteresis*)

Sinking Switch* A switch where current flows into the sensor to ground from an externally sourced load when turned ON (output voltage low when ON).

SenixVIEW Senix PC-based software used to configure and install ToughSonic sensors.

Sourcing Switch* A switch where current flows from the sensor (sensor power input is the source) to the load when turned ON (output voltage high when ON).

Switch* An electrical output type that is either ON or OFF. ToughSonic® switches are solid state and can be either sinking or sourcing type.

SYNC* A wired configuration that synchronizes the timing of two or more sensors to prevent crosstalk or ensure simultaneous measurements.

SYNC Interval The time interval of measurement of all SYNC sensors. It equals the number of *SYNC phases* x *measurement interval*.

Target Any object or material that reflects ultrasonic energy back to the sensor thus allowing the sensor to measure its distance.

Target Indicator A rear indicator that shows the status of a detected target and more.

Teach* A Senix product feature that uses a pushbutton to store a current target distance measurement into memory and automatically calibrate the output(s).

Time Delay* A time period triggered by a set of conditions and, after those conditions persist for the entire period, cause a secondary event to occur. There are several user-selected time delay features available.

Ultrasonic A sound wave of a frequency greater than 20,000 Hz, typically above the range of human hearing.

Voltage Output* An *analog* output type that drives an electrical voltage proportional to measured distance. ToughSonic sensors provide industry standard or SenixVIEW customized output ranges.

Ultrasonics Overview

Introduction

Senix sensors measure the distance or presence of a target object by sending a sound wave, above the range of hearing, at the object and then measuring the time for the sound echo to return. Knowing the speed of sound, the sensor can determine the distance of the object from the transducer element.

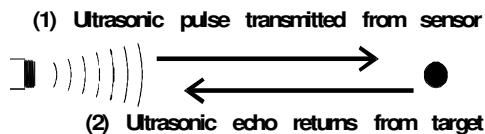

Advantages

- **Non-contact**

Measures through the air without touching the target object, at relatively large distances.

- **Object Ranging**

Object distance is measured rather than just the presence or proximity.

- **Distance Proportional Output**

The sensor's outputs are proportional or affected by the measured target distance.

- **High Resolution**

Precise discrimination of target position.

- **Unaffected by Target's Optical Characteristics**

The sensor's operation is not sensitive to ambient light levels, the color of the target, or target is optically transparency/reflectivity.

- **Sensitive**

Detects large and small objects (smaller objects must be closer)

Typical Applications

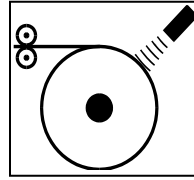

Roll Diameter

Measure the size of a roll to control tension or speed, or determine when full or empty.

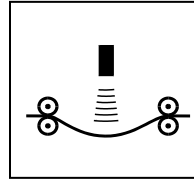

Loop Control

Precisely control the position of material loops, including wires, tubes and webs.

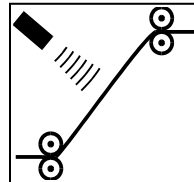

Web Break

Rapidly detect a broken web in a printing press or paper machine.

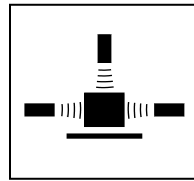

Dimensioning

Determine the size of an object for information or to determine its volume or width.

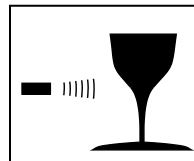

Proximity

Determine the presence of objects to count or control their movement.

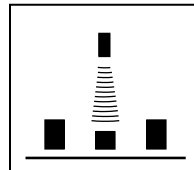

Sort/Select

Sort or select objects based on differences in their physical dimensions.

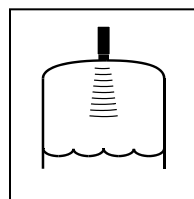

Level Measurement

Measure or control the level of liquid or solid materials in tanks or bins for inventory or batching...*and many more...*

Sensor Overview

ToughSonic Product Features

ToughSonic® sensors measure distance without contact and are designed for tough industrial environments.

Rapid PC Setup & Control



PC setup gives you control over all sensor outputs and features. View, analyze and save sensor setups for rapid implementation or cloning.

Pushbutton “Teachable”

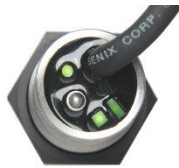

Some models utilize a rear TEACH button to make many common adjustments. See the Teach Adjust section. Rear indicators provide target and output status. The TEACH button can be disabled for security

using SenixVIEW. The TEACH button is unavailable on the ToughSonic 50 and 50RM models and serial-only models.

Packaging

ToughSonic models are housed in rugged 316 stainless steel or durable PVC, with permanently attached interface cables. Sensors are potted and sealed to operate in wide humidity and temperature ranges.

Industry Standard Interfaces

Multiple simultaneous outputs, each with many SenixVIEW adjustable features.

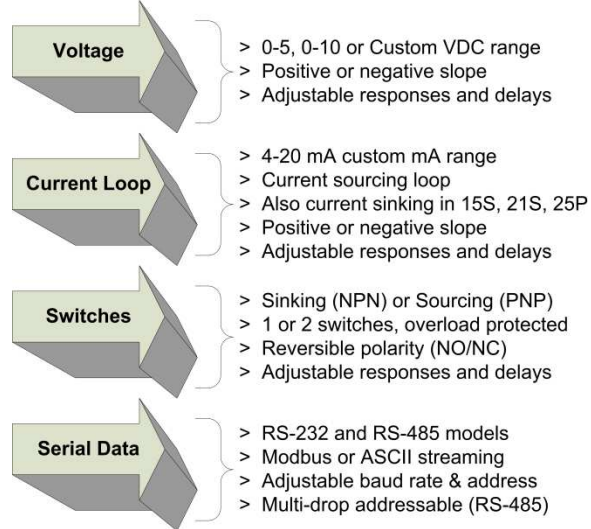

Part Numbers

TSPC-xxxxx-xxxx-xxxx

Custom

SERIAL DATA INTERFACE & Outputs

- 232:** RS-232 (PC COM port), multiple outputs
- 232A:** RS-232 (PC COM port), serial only
- 485:** RS-485, addressable, multiple outputs
- 485A:** RS-485, addressable, serial only

HOUSING, MOUNT, MAX RANGE, & TRANSDUCER

- 30S1:** SS316, m30 thread, 14 ft
- 30S1K:** SS316, m30 thread, 12 ft, PVDF
- N1S1:** SS316, 1-in NPT thread, 14 ft
- N1S1K:** SS316, 1-in NPT thread, 12 ft, PVDF
- 30S2:** SS316, m30 thread, 3 ft
- N1S2:** SS316, 1-in NPT thread, 3 ft
- 15S:** SS316, dual 1.5-in NPT thread, 30 ft
- 21S:** SS316, smooth cylinder housing, 50 ft
- 21SR:** SS316, rear 1.5-in NPT thread, 50 ft
- 25P:** PVC, dual 2.5-in NPT thread, 50 ft

PRODUCT SERIES

TSPC: ToughSonic® PC Configurable Sensor
Standard embedded 6.5ft (2m) PUR serial cable

Figure 1 - Part Number Structure

Identification

The ToughSonic® model number and serial number are printed on the label on the side of the housing.

Startup Tips

New or first-time users can use this condensed guide for assembly, connection to a PC, and basic sensor changes from default values before installation. The sensor communicates with a Windows PC through the serial port or USB port. A UAN-Kit from Senix is recommended for connecting to your PC. It includes software, a termination board, and cables (see page **Error! Bookmark not defined.**).

▪ Install the Software

Put the SenixVIEW thumb drive into your PC. Open the contents and run SenixVIEW Version 3.4.xxx Setup.exe to install. Start SenixVIEW.

▪ Connect the Components

The sensor uses colored wires for power, communication, and outputs. For a basic terminal board connection, we'll use 4 of the sensor's wires:

- Brown for DC power (DC+)
- Blue for ground (GND and digital reference)
- Gray and Yellow for digital communication.

Connect them to the labeled Senix terminal board. Protect all bare wires from contacting one another whether connected or not. Ensure the terminal grips the stripped wire, not its colored jacket. Plug the data communication cable into the terminal board RJ jack and your serial port (-232 models), or into the USB adapter (optional for -232 and required for -485 models). (For USB adapters see page 15)

Put the DC power supply cable into the jack on the terminal board, and the supply into an AC source. All sensors will faintly tick when powered.

▪ Connect to Your Sensor (using serial port)

Start SenixVIEW.
Menu bar: Sensor >Connect for a dialog box. All new sensors have network address 1. Use Baud rate 9600. The serial port is generally identified COM 1. Click Connect.

▪ OR Connect to Your Sensor (using a USB port)

Start SenixVIEW.
Menu bar: Sensor >Connect for a dialog box. All new sensors have network address 1. Use Baud rate 9600. Select the COM port from the choices or run Com Port Survey. If COM port is higher than the 12 shown. Edit >User Preferences...> Connection/ Starting COM port:

and enter new start number. Return to Connect Sensor and repeat connection with any available green ports. For more detail, see "Connect a Sensor", page 45.

▪ SenixVIEW Quick Tour

Once a sensor is connected, it can be viewed in the SENSOR view. Any changes are done in the WORKSPACE view and transferred to the sensor.

Basic layout of the main screen:

- Range and basic setup values, all editable.
- Workspace and Sensor views
- File saving and retrieval button
- Dialog screens for additional setup
- Analysis tools
- Output setup and simulated meters (editable)

Setup Basics (advanced description starts page 21)

When sensor is found, answer YES to copy sensor setup to the Workspace. You are left in Sensor View showing the sensor reading and its current setup.

To make changes, click the WORKSPACE button.

-To change a Range, Endpoint, or output value, just click on the value and enter a new one.

-To reverse the analog slope, right-click the High- or Low-value endpoint.

-To assign outputs, click WIRING and assign black and white wires as needed. Any changes in Workspace make it different than the Sensor, shown by the unequal symbol. Transfer WORKSPACE to SENSOR.

▪ Save the Setup to the Sensor

To move changes to sensor, right click and drag WORKSPACE to SENSOR. Any changes not sent to the sensor will be lost when closing SenixVIEW.

▪ Save the Setup to the PC.

Right click WORKSPACE and drag it to FILE.

▪ Mounting Tips

Sensor must be mounted perpendicular to the object to be measured for sound echoes to return. The sensor cannot sense in a space less than the default Minimum Range value. The sensor will ignore targets or surfaces beyond the Max Range value. Avoid echoes from pipe fittings, welds, and fixed objects with careful placement. The sensor will return a distance value from the first surface found within range. Contact Senix technical support for setup assistance.

Specifications

A summary of sensor specifications and features is shown in the following table.

Model Name Part number, Metric Part number, NPT	ToughSonic 3 TSPC-30S2-xxxx TPC-N1S2-xxxx	ToughSonic 12 TSPC-30S1K-xxxx TSPC-N1S1K-xxxx	ToughSonic 14 TSPC-30S1-xxxx TSPC-N1S1-xxxx
Photo			
Maximum Range Deadband (minimum)	3 ft (91cm) 1.75 in (4.4 cm)	12 ft. (3.7 m) 3 in. (76 mm)	14 ft. (4.3 m) 4 in. (10.2 cm)
Optimum Range (small targets, dry materials, hot)	1.75 in (4.4 cm) to 24 in (61cm)	3 in. (76 mm) to 8 ft (2.4m)	4 in. (10.2 cm) to 10 ft (3m)
Outputs, full-featured models: Table	Two outputs: SenixVIEW selectable as 0-10 VDC (or custom), 4-20 mA (or custom) sourcing, PNP or NPN switches		
	Switches: 150 mA, SenixVIEW configured as PNP (@ input voltage) or NPN (external 40 VDC max.), setpoint mode or window mode		
	Voltage: 0-10 or SenixVIEW configured, 10 mA max (min 15 VDC input for full 10 VDC output)		
Outputs, Serial-only: NONE	Current Loop: 4-20 mA or SenixVIEW configured, 450Ω max @ >15VDC, 250Ω max @ 10 VDC		
Indicators	Round LED: Power/Target. Square & Rectangular LEDs: Data, switch or analog status (configurable)		
	Serial-only models: Round LED Power/Target		
Serial interface, Interface protocol	Modbus slave, ASCII, or SYNCH. RS-232 or RS-485 interface, depends on model. RS-485 models are 2-wire multi-drop addressable (addresses 1-247). Baud rates 9600 - 115200, none or even parity, 8 bits, one stop bit. SenixVIEW configured.		
Power Input	10-30 VDC @ 55 mA max		
DC Current @ typical 24VDC input +I/O	Typical 45 mA @ 24VDC input +I/O		
DC Current, Serial- only	Typical 30 mA @ 24VDC	Typical 35 mA @ 24VDC	Typical 35 mA @ 24VDC
Environmental	Ingress: IP-68, NEMA-4X Humidity: 0-100% (avoid heavy condensation) Temp: -40 to +158 F (-40 to +70 C)		
Transducer frequency	240 kHz	120 kHz	120 kHz

ToughSonic® Family Sensors – Installation & Operating Instructions

Model Name Part number, Metric Part number, NPT	ToughSonic 3 TSPC-30S2-xxxx TPC-N1S2-xxxx	ToughSonic 12 TSPC-30S1K-xxxx TSPC-N1S1K-xxxx	ToughSonic 14 TSPC-30S1-xxxx TSPC-N1S1-xxxx
Transducer, Beamwidth	Rugged piezoelectric, nominal beam width ~12 degrees @ -3 dB, approx. conical shaped pattern	PVDF piezoelectric, nominal beam width ~12 degrees @ -3 dB, approx. conical shaped pattern	Rugged piezoelectric, nominal beam width ~12 degrees @ -3 dB, approx. conical shaped pattern
Measurement rate	Default: 50 msec (20 Hz)		
	Adjustable from 5 msec to 2.8 hours; faster rates limit max target distance		
Performance	Repeatability: Greater of +/-0.03 in. (0.76 mm) or 0.25% of target distance in stable environment Accuracy: Better than 0.5% of target distance in stable, homogeneous air environment; affected by temperature gradients, target echo strength, speed of sound in air or vapors.		
Resolution (analog)	4100 steps over 0-10 VDC and 3279 steps over 0-20 mA (scaled between user-set distance endpoints)		
Resolution (serial data)	0.0034 in. (0.086 mm)		
Temperature	-40 to +158F (-40 to +70C) Temperature Compensated by internal sensor or external Reference Target		
Adjustments	Pushbutton Teach (except in serial-only version) or SenixVIEW software (included)		
Cable, full outputs (embedded)	6.5-ft (2m) 6-wire with shield, tinned ends, PUR. Longer cables available. M12 connector on 18" cable available with extension cables available		
Cable, serial-only (embedded)	6.5-ft (2m) 4-wire with shield, tinned ends, PUR. Longer cables available. M12 connector on 18" cable available with extension cables available		
Max serial cable length	RS-232: 50ft (15 m), RS-485: 3937ft (1200m).		
Weight	10.3 oz. (0.29 kg)	10.4 oz (0.29 kg)	10.4 oz (0.29 kg)
Housing material, Mount	316 Stainless, M30x1.5 mm thread OR 316 Stainless, 1-in NPT thread		
Dimensions (Dia x Length)	1.2 in. (30.4mm) x 4.064 in. (103mm)		
Default: RangeMIN	1.75 in. (4.4 cm)	3 in. (76 mm)	4 in. (10.2 cm)
RangeMAX	36 in. (91 cm)	144 in. (3.7 m)	168 in. (427 cm)
Switch #1 Setpoint	12 in. (30.5 cm)	12 in. (30.5 cm)	12 in. (30.5 cm)
Switch #2 Setpoint	18 in. (46 cm)	18 in. (46 cm)	24 in. (61 cm)
Analog Low Endpoint	1.75 in. (4.4 cm)	96 in. (244 cm)	4 in. (10.2 cm)
Analog High Endpoint	24 in. (61 cm)	3 in. (7.6 cm)	120 in. (305 cm)
Options Interface:	RS-232 or RS-485		
Mount method:	m30x1.5 or 1-in NPT thread		
Outputs:	Two outputs or serial only		

Senix Corporation, 10516 Route 116 Suite 300, Hinesburg, VT 05461 USA

Web: www.senix.com, e-mail: Technical.Support@senix.com

ToughSonic® Family Sensors – Installation & Operating Instructions

Model Name Part Number	ToughSonic 30 (TSPC-15S-xxxx)	ToughSonic 50 (TSPC-21S-xxxx) & ToughSonic 50RM (Rear mounted) (TSPC-21SR-xxxx)	ToughSonic 50P (TSPC-25P-xxxx)
Photo			
Maximum Range Deadband (minimum)	30 ft (9.1 m) 10 in (25.4 cm)	50 ft (15.2 m) 12 in (30.5 cm)	
Optimum Range (small targets, dry materials, hot)	20 ft (6.1 m)	33 ft (10.1 m)	
Outputs, full-featured models: Table	Five Outputs: 0-10 VDC, 4-20 mA sourcing, 4-20 mA sinking, two switches		
	Switches: 150 mA, SenixVIEW configured as PNP (@ input voltage) or NPN (external 40 VDC max.)		
Outputs, Serial-only: NONE	Voltage: 0-10 or SenixVIEW configured, 10 mA max (min 15 VDC input for full 10 VDC output)		
	Current Loop: 4-20 mA or SenixVIEW configured, 450Ω max @ >15VDC, 250Ω max @ 10 VDC		
Indicators	Round LED: Power/Target. Square & Rectangular LEDs: Data, switch or analog status (configurable) 50RM and 50RM Serial only: None		
	Serial-only models: Round LED Power/Target (except 50RM)		
Serial interface, Interface protocol	Modbus slave, ASCII, or SYNCH. RS-232 or RS-485 interface, depends on model. RS-485 models are 2-wire multi-drop addressable (addresses 1-247). Baud rates 9600 - 115200, none or even parity, 8 bits, one stop bit. SenixVIEW configured.		
Power Input	10-30 VDC @ 70 mA max		
DC Current @ typical 24VDC input +I/O	Typical 45 mA @ 24VDC input +I/O		
DC Current, Serial-only	55 mA max, Typical 35 mA @ 24VDC		
Environmental	Ingress: IP-68, NEMA-4X Humidity: 0-100% (avoid heavy condensation) Temp: -40 to +158 F (-40 to +70 C)		
Transducer, Beamwidth	Rugged piezoelectric, nominal beam width ~12 degrees @ -3 dB, approx. conical shaped pattern		
Transducer frequency	75 kHz	50 kHz	50 kHz
Measurement rate	Default: 100 msec (10 Hz)	Default: 200 msec (5 Hz)	
	Adjustable from 5 msec to 2.8 hours; affected by filter selections		

Senix Corporation, 10516 Route 116 Suite 300, Hinesburg, VT 05461 USA

Web: www.senix.com, e-mail: Technical.Support@senix.com

ToughSonic® Family Sensors – Installation & Operating Instructions

Model Name Part Number	ToughSonic 30 (TSPC-15S-xxxx)	ToughSonic 50 (TSPC-21S-xxxx) & ToughSonic 50RM (Rear mounted) (TSPC-21SR-xxxx)	ToughSonic 50P (TSPC-25P-xxxx)
Performance	Repeatability: 0.2% of target distance in stable environment Accuracy: Better than 0.5% of target distance in stable, homogeneous air environment; affected by temperature gradients, target echo strength, speed of sound in air or vapors.		
Resolution (analog)	4100 steps over 0-10 VDC and 3279 steps over 0-20 mA (scaled between user-set distance endpoints)		
Resolution (serial data)	0.0068 in. (0.172 mm)	0.0135 in. (0.343mm)	
Temperature	-40 to +158F (-40 to +70C) Temperature Compensated by internal sensor or external Reference Target		
Adjustments	Pushbutton Teach (except on serial-only models) or SenixVIEW software (included)	SenixVIEW software (included)	
Cable, full outputs (embedded)	6.5-ft (2m) 9-wire with shield, tinned ends, PUR. Longer cables available. M12 connector on 18" cable available with extension cables available		
Cable, serial-only (embedded)	6.5-ft (2m) 4-wire with shield, tinned ends, PUR. Longer cables available. M12 connector on 18" cable available with extension cables available		
Max serial cable length	RS-232: 50ft (15 m), RS-485: 3937ft (1200m).		
Weight	22.6 oz. (0.64 kg)	29.9 oz (0.82 kg)	29.1 oz (0.82 kg)
Housing material, Mount	316 Stainless, Dual 1.5 in NPT	316 Stainless cylinder, Clamp to mount 50RM: rear 1.5 in NPT	PVC, Dual 2.5 in NPT
Dimensions (Dia x Length)	1.2 in. (30.4mm) x 4.064 in. (103mm)	50: 2.3 in (59mm) x 4.8 in (122 mm)	2.5 in (63.5 mm) x 5.0 in (127 mm)
		50RM: 2.5 in (63 mm) x 5.9 in (150mm)	
Default: RangeMIN RangeMAX Switch #1 Setpoint Switch #2 Setpoint Analog Low Endpoint Analog High Endpoint	10 in. (25.4 cm) 30 ft. (9.1 m) 36 in. (91.4 cm) 48 in. (121.9 cm) 10 in. (25.4 cm) 240 in. (609 cm)	12 in. (30.5 cm) 50 ft. (15.2 m) 36 in. (91.4 cm) 48 in. (121.9 cm) 12 in. (30.5 cm) 400 in. (1016 cm)	12 in. (30.5 cm) 50 ft. (15.2 m) 400 in. (1016 cm) 18 in. (45.7 cm) 400 in. (1016 cm) 12 in. (30.5 m)
Options Interface:	RS-232 or RS-485		
Mount method:	1.5 in NPT both ends	Clamp. (50RM: rear thread 1.5-in NPT)	2.5 in NPT either end
Outputs:	Five outputs or serial only		

Senix Corporation, 10516 Route 116 Suite 300, Hinesburg, VT 05461 USA

Web: www.senix.com, e-mail: Technical.Support@senix.com

Mechanical Details

Dimensions are inches (mm). Distance is measured between the ultrasonic transducer face (the end opposite the cable) and the target.

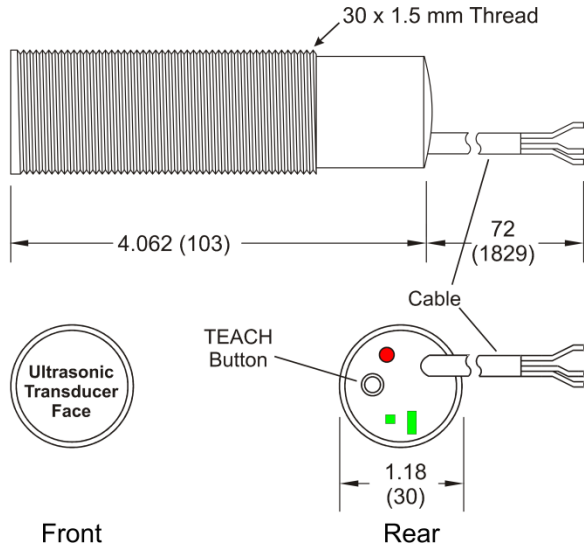
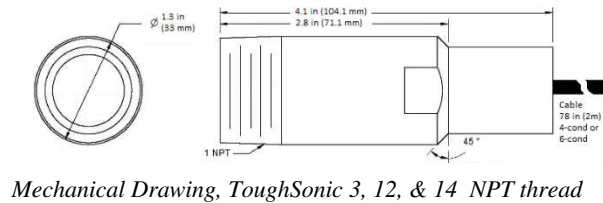

Figure 2 - Mechanical Drawing, ToughSonic 3, 12, 14 metric thread



Mechanical Drawing, ToughSonic 3, 12, & 14 NPT thread

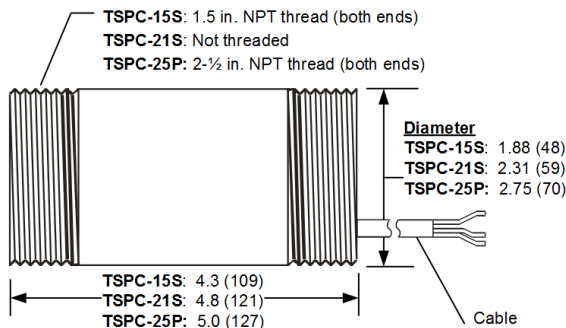

Figure 3 - Mechanical Drawing, ToughSonic 30, 50, and 50P

Mounting and Installation

Precautions

Only hand tighten the sensor and never apply a wrench to the body. When tank mounting to a domed or round tank, mount the sensor perpendicular with the target surface. Mount the sensor directly to the tank ceiling at a flanged opening. If a riser is added, it must be smooth-walled and a minimum 3-in diameter. The sensor beam width is nominally 12-14 degrees at the -3dB boundary, however surfaces outside that can return echoes as well. Round off the lower ID of the riser to prevent detection. Provide shade for outside installations to prevent erroneous measurements due to artificial heating of the sensor when temperature compensation is active. Mount the sensor away from the inner walls of tanks. Seams and fixtures can interfere with measurements.

Orientation

Orient the sensor perpendicular to the target object for best results as shown in Figure 4.

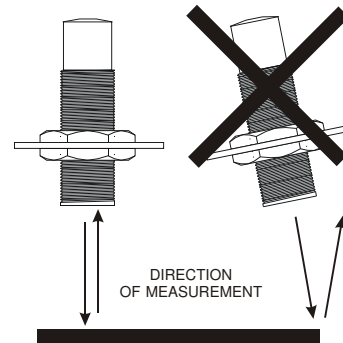

Figure 4 - Sensor Orientation

Ultrasound energy must return to the sensor or the sensor will not detect a target. Curved or spherical objects generally reflect a portion of the energy back to the sensor but with lower reflected energy. A flat surface, however, is detectable at a greater distance. Foreground interfering objects can be ignored by setting the Range MIN value in SenixVIEW.

Maintenance & Cleaning

Dust accumulation on the sensor face can be cleaned by blowing pressurized air across the sensor face. Dust does not affect performance unless it builds on the transducer. Positioning the sensor facing downward rather than upward will minimize material accumulation in some applications. The sensor face

can be cleaned with isopropyl alcohol or window cleaner. DO NOT use solvents such as MEK or acetone on ToughSonic sensors.

Metric ToughSonic 3, 12, and 14

These sensors are shipped with two 30mm stainless nuts. The sensor mounts through a 1.18-in (31mm) hole in a mounting plate as shown in Figure 5. This hole may be a component of the user equipment or a Senix bracket and must be rigid for best performance. Position the sensor in the hole and fasten it to the plate with the two nuts provided. The sensor position can be altered a couple of inches depending on the nut positions. If accurate close-range distance is important, position the sensor so the closest target is always beyond the deadband (also see *Range MIN* on page 34).

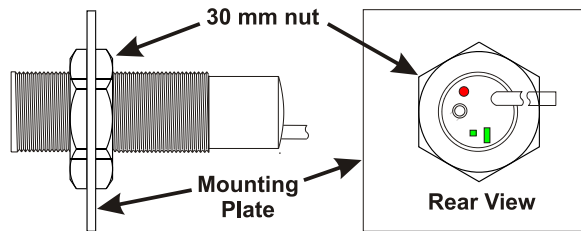

Figure 5 - Mounting

NPT ToughSonic 3, 12, and 14

These sensors have 1-in NPT male threads at the front end to install in a 1-in NPT threaded hole, flange or 90-degree adapter. The sensor can also be held by clamp.

Mounting Hardware & Accessories Metric ToughSonic 3, 12, and 14 series

	UA-MB30-SS Stainless steel, flat bracket, non-adjustable angle
	UA-MB30-SS90 Stainless steel, 90-degree mounting, non-adjustable angle
	UA-MB30-NYBM Nylon, clamps to sensor, non-adjustable angle.
	UA-MB30-NYSW Nylon adjustable angle bracket with internal 30mm thread. Adjust sensor angle, then tighten to lock sensor in position
	UA-SWD-30-2NPT Delrin adapter allows 30mm threaded sensor to mate with 2-in. NPT flange or nipple. Elevates 2-in for use with 2-in flange.
	UA-SWED-30-2NPT Delrin adapter allows 30mm threaded sensor to mate with 2-in. NPT flange or nipple. Elevates 4-in for use with 2-in flange.
	UA-NUT30-SS One pair (SS316).stainless steel m30x1.5 nuts (Included with new sensor)
	UA-90D-1N 90 Degree Mounting adapter, external style with target for 1 in. NPT Thread
	UA-RT1-30 Reference Target Adapter, external style with target for 30mm Thread
	UA-RT1-1N Reference Target Adapter, external style with target for 1 in. NPT Thread

ToughSonic® Family Sensors – Installation & Operating Instructions





ToughSonic 30 Series

The ToughSonic 30 threads into a 1.5-in NPT flange or pipe thread.

	<p>UA-CLIC-15 PVC bracket Optional for ToughSonic 30</p>
	<p>UA-FM-15 Gray PVC flange for 1.5-in NPT</p>
	<p>UA-FM-SS15 Stainless steel flange. Fits rear mount ToughSonic 50RM</p>

ToughSonic 50 Series

ToughSonic 50 series includes stainless steel and PVC housings.

	<p>UA-CLIC-21 PVC bracket Included with ToughSonic 50</p>
	<p>UA-MB-SS Stainless steel clamp bracket bolts to surface in fixed position Optional for ToughSonic 50</p>
	<p>UA-FM-SS15 Stainless steel flange. Fits rear mount ToughSonic 50RM</p>
	<p>UA-FM-15 Gray PVC flange. Fits rear mount ToughSonic 50RM</p>

ToughSonic 50P Series

ToughSonic 50P model threads into a 2.5-in NPT flange or pipe nipple. Observe precautions (page 12).

	<p>UA-FM-25 Gray PVC flange with 2-in NPT thread. Fits ToughSonic 50P</p>
	<p>UA-FM-SS25 Stainless steel flange. Fits ToughSonic 25P</p>









Connectors

Sensors can be ordered with 5-pin M12 connectors or with 6- or 8-pin Deutsch connectors. Standard sensor cable length is 12 inches to the connector. Standard and Custom pin assignments are available. Standard mating cable length is 6ft and custom mating cable lengths are available. Contact Senix for ordering details and prices.



Software and Interconnection

The following accessories are available.

Configuration and Communication	
	<p>SenixVIEW Software Configure, test and clone sensors. Compatible with all ToughSonic models. Download free from www.senix.com</p>
	<p>UAN-KIT-USB-232 UAN-KIT-USB-485 PC Interface kits. Choose RS-232 or RS-485 to match sensor. Converter, terminal block, power supply, data cable, thumb drive included.</p>
	<p>UA-USB-232-ISO Use with UA-CC-232 to connect to a USB port at the PC with Isolated inputs. 3 ft USB cable</p>
	<p>UA-USB-485-ISO Use with UA-CC-485 to connect to a USB port at the PC with Isolated inputs.</p>
	<p>UA-CC-232 UA-CC-485 DB9 adapter and 6-ft data cable. Joins ISO converter to termination boards.</p>
	<p>UA-USB-232-TB UA-USB-485-TB Non-isolated serial converter to USB with termination board and 3-ft USB cable</p>
	<p>UA-TS-TB Termination Board to connect any model sensor, user equipment, power, and serial interface cable. DIN rail mounts included</p>
	<p>UA-TS-TB-2RYC Termination board with 2 relays (driven by sensor switch outputs), power input, serial interface jack. For any model sensor</p>
	<p>UA-JBOX-485 RS-485 Serial and Power wiring junction box, used on all serial-only sensor networks</p>

	<p>UA-DATACORD 6-ft with RJ11 each end. For patching termination board and serial converter.</p>
--	---

Rear Features

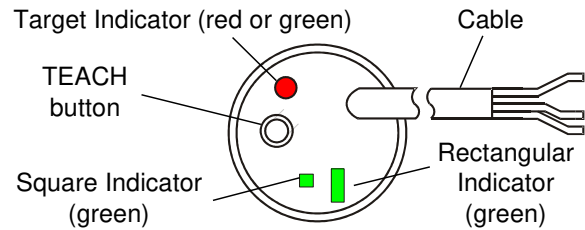

Figure 6 - Sensor Rear Features

There are four control features available:

The **TEACH button** can be used to make sensor adjustments on ToughSonic 3, 12, 14, and 30 series sensors (or can be disabled using SenixVIEW). Teach features are described on page 50.

The **target indicator** (round) shows the target status and other conditions. It is always ON when power is applied and will be either RED or GREEN.

The **square status indicator** and **rectangular status indicator** show sensor outputs status as described in Target Indicator on page 16. Status Indicator assignments can be changed using SenixVIEW. The factory defaults by model are:

- ToughSonic 3, 12, and 14:
Square = Analog, Rectangular = data TX
- ToughSonic 30:
Square = Switch #1, Rectangular = Switch #2
- ToughSonic 50:
Square = Switch #1, Rectangular = Switch #2
- ToughSonic 50RM:
No pushbutton or LEDs
- ToughSonic 50P:
Square = data RX, Rectangular = data TX
No pushbutton

ToughSonic® Family Sensors – Installation & Operating Instructions

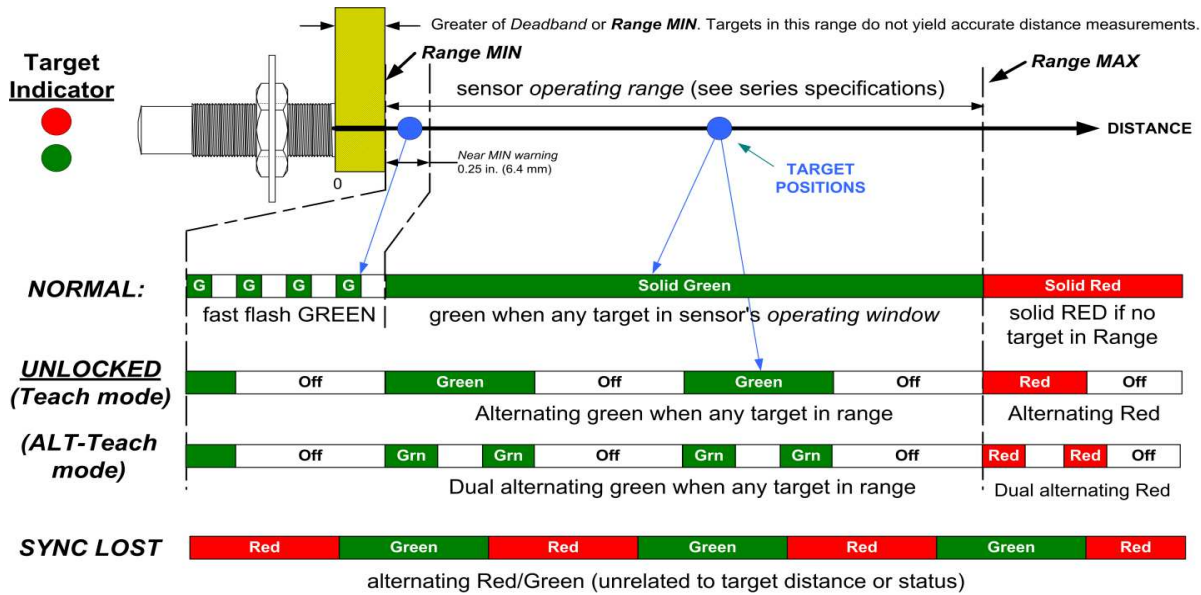

Figure 7 - Target Indicator Functions

Target Indicator

As shown in the figure above, the *target indicator* is a bi-color LED and provides status for the following purposes:

- Power ON
- Target status & near MIN
- Data communications
- “No SYNC” warning
- Unlocked status
- TEACH feedback (ToughSonic 3, 12, 14, and 30)

Power ON Status

When sensor power is ON the *target indicator* will be RED or GREEN. It may also be flashing at a slow or fast rate under other conditions described below and shown in figure 7.

Target Status & Near MIN

This is the primary operational purpose of the *target indicator*. The target status displays follows:

- GREEN is a normal indication, indicating a target is detected within the sensor's *operating range*
- RED indicates no target is detected within the sensor's *operating range*.
- FAST FLASH GREEN warns that the target is within 0.25 in. (6.4 mm) of *range MIN*.

Unlocked Status (ToughSonic 3, 12, 14, and 30)

The sensor must be unlocked for TEACH adjustment. When unlocked the *target indicator* will continue to indicate target status (Red or Green) but will blink slowly on and off to signify TEACH readiness. ALT-Teach status is indicated by an alternating “double blink”. All filters are turned OFF when unlocked.

TEACH and ALT-Teach Feedback (ToughSonic 3, 12, 14, and 30)

When using the TEACH features to make sensor adjustments the *Target Status* Indicator will SLOW BLINK RED (unless the TEACH functions are disabled using SenixVIEW and the sensor is not a SYNC master or slave) as operator feedback while the *TEACH button* is pressed. The user must count these flashes, then release the *TEACH button* after a specific number of flashes to complete a particular TEACH feature. ALT-Teach feedback is indicated by a slow “double blink”.

“No SYNC” Warning

If the SYNC feature is used (see page 33) and a slave sensor does not detect a master SYNC input, the slave will stop measuring and the *Target Status* indicator will slowly alternate between RED and GREEN until SYNC is restored (or the TEACH button is used on certain models).

Output Status Indicators

Some ToughSonic sensors have two output status indicators at the rear of the sensor. These indicators can each show status of the analog, switch or serial data interfaces, or can be turned OFF. Indicators have default assignments and can be reassigned using SenixVIEW. Indicator operations are shown in figure 8

In a typical installation the analog output is operating within a user-calibrated range and the normal indication is a continuously ON indicator. An OFF or blinking indicator could indicate a potential problem because the sensor is detecting a target outside the calibrated (expected) distance range.

Default Indicator Assignments

- ToughSonic 3, 12, and 14:
Square = Analog, Rectangular = data TX
- ToughSonic 30 and 50S:
Square = Switch #1, Rectangular = Switch #2
- ToughSonic 50RM:
No indicators
- ToughSonic 50P:
Square = data RX, Rectangular = data TX

Square Green Indicator - ■

The square status indicator can be configured using SenixVIEW to any of the status options (analog, switch, serial data receive, serial data transmit, Reference Target, or OFF). If selected for a switch it displays the status for Switch #1. The #1 output must be configured to be a switch in order to choose Switch as the indicator. Similarly Reference Target temperature compensation must be chosen before assigning Reference Target to the square indicator.

Rectangular Green Indicator - ▮

The rectangular status indicator can be configured using SenixVIEW to any of the status options (analog, switch, serial data receive, serial data transmit, Reference Target, or OFF). If selected for a switch it displays the status for Switch #2. The #2 output must be configured to be a switch in order to choose Switch as the indicator. Similarly, Reference Target temperature compensation must be chosen before assigning Reference Target to the square indicator.

Switch Status

When a status indicator is selected as a solid state *switch*, it operates as follows:

- Indicator ON if *switch* is ON
- Indicator OFF if *switch* is OFF
- Indicator blinks on and off continuously while the *switch* is in a safe shutdown mode due to over current or temperature.

The *Output Selection* for a *Switch* may be either *sinking* or *sourcing* but the status indication is the same. A *switch* is considered ON when it is **conducting current** (see page 23).

Analog Status

When a status indicator is selected for analog status it shows the current status of the analog output(s). The analog status is the same for voltage and current loop outputs since they share common *endpoint* distances. The analog status indicator:

- is ON if the target distance is between the two analog *endpoint* distances over which the analog output is spanned, or
- is OFF if the target distance is equal to or outside the low value endpoint distance. The sensor output will be 0 VDC, 4 mA or the SenixVIEW adjusted low analog output value, or
- blinks ON-OFF if the target distance is equal to or outside the high value *endpoint* distance. The sensor output will be 5/10 VDC, 20 mA or the SenixVIEW adjusted high analog output value.

Serial Data Status

In systems using serial data communications a status indicator(s) can be configured using SenixVIEW to either (a) RX flash upon receiving any data (regardless of validity or baud rate), or (b) TX flash upon transmitting data (responding to a valid command). A TX indicator will also flash each time data is transmitted in the ASCII streaming mode.

Reference Target Status

Either status indicator can be configured to light when the reference target is available and go out if it is lost. Available only in Reference Target temperature compensation mode. Unavailable in Serial Only models.

ToughSonic® Family Sensors – Installation & Operating Instructions

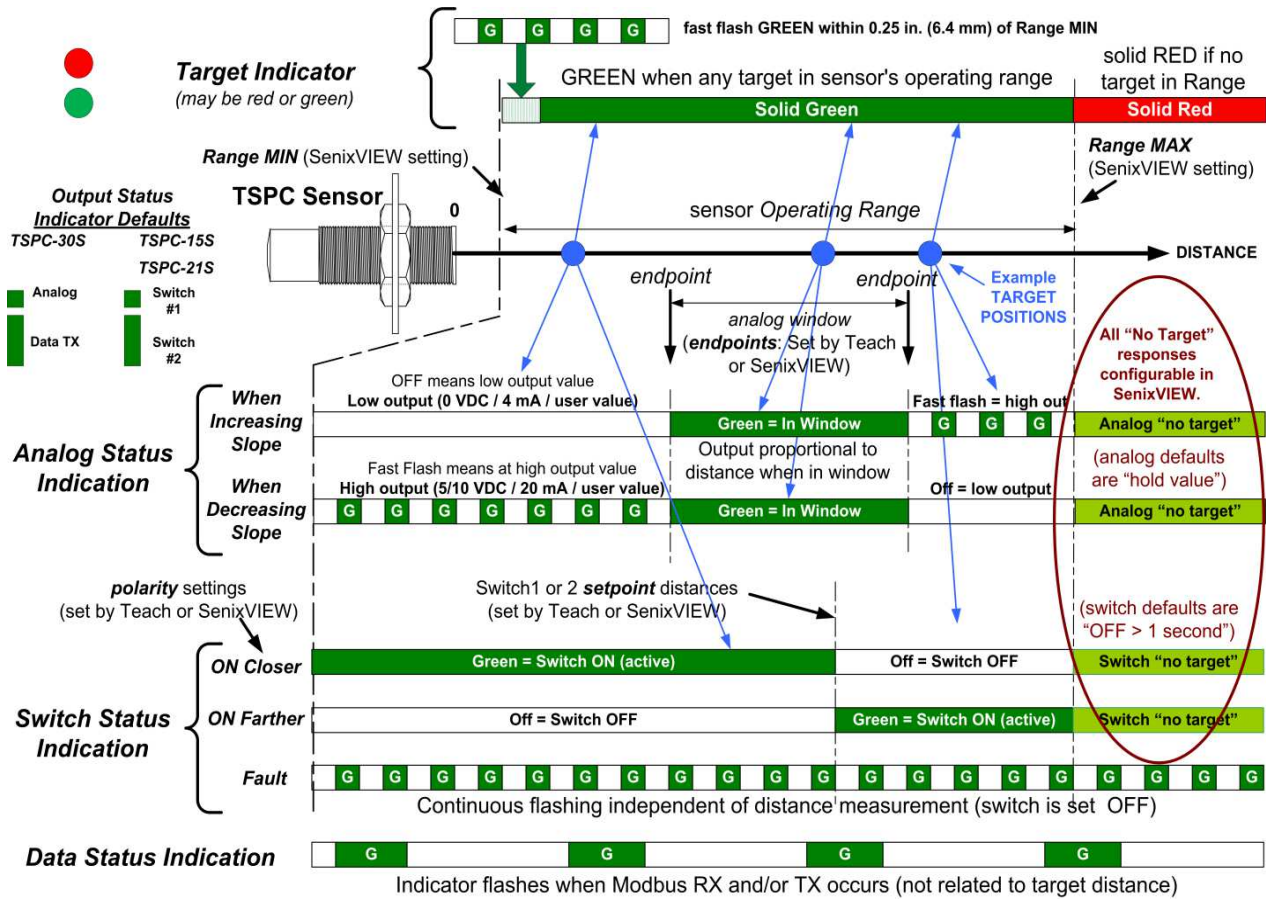

Figure 8 - Output Status Indicator Operations

Output Status Indicators (■ & □): Analog, switch, reference target, and/or data status is shown on the square indicator (■) and/or rectangular indicator (□). Default assignments may be changed using SenixVIEW. Analog status appears for current loop or voltage outputs, and Switch Status for sinking or sourcing switch outputs. Reference target is to monitor for that type of temperature compensation.

Analog Status: The above two analog examples show an increasing analog slope (top) and decreasing analog slope (bottom). An increasing slope means the output value increases proportional to the measured distance and vice versa. A fast flashing analog indicator means the analog output is at the high endpoint voltage or current output value (10 VDC, 5 VDC, 20 mA, or user value entered in SenixVIEW). An OFF analog indicator means the analog output is at the low endpoint voltage or current output value (0 VDC, 4 mA, or user value entered in SenixVIEW). The analog status is solid green when the measurement is within the normal (calibrated) range.

Switch Status: The indicator will light green when the associated switch is ON. An ON switch means it is conducting current, and an OFF switch not. A sinking switch output that is ON will have an output value near ground (0 volts). A sourcing switch output that is ON will have an output value near the power supply voltage. The three switch examples shown above demonstrate a switch that is ON at distances closer than the setpoint (ON closer), farther than the setpoint (ON Farther) and a FAULT condition (overload or over temperature). During a FAULT the switch is turned OFF. Normal switch operation restores automatically when the fault is removed.

Analog and Switch Outputs if No Target: If no target is detected (target indicator is red) the analog output will hold the last value and the switch outputs will turn off after 1 second. These responses can be changed in SenixVIEW by changing the "No Target Voltage" and "No Target Current" selections.

Data Status: The status indicator will flicker ON when the sensor receives (RX status) or responds (TX status) to a Modbus command over the serial data interface.

INTERFACES

Wires Identification

ToughSonic sensors have an attached, embedded 6.5ft cable as standard. It is a shielded 4-wire, 6-wire or 9-wire cables with the following wire assignments:

Wire Color	Wire Function	
	ToughSonic 3, 12, and 14 Series (6-wire cable)	ToughSonic 30 and 50 Series (9-wire cable)
Brown	+DC input voltage (Power Input)	
Blue	-DC input and signal common (Ground)	
Gray (data #1) (note 2)	RS-232 models:	RS-232 out
	RS-485 models:	RS-485 -
Yellow (data #2) (note 2)	RS-232 models:	RS-232 in
	RS-485 models:	RS-485 +
Silver	Cable shield (bare stranded wire), unterminated at sensor end	
Colors below are not on Serial Only models		
Black	Output #1 (note 1) 4-20 mA sourcing loop (note 3) OR Sinking Switch #1 OR Sourcing Switch #1 or OFF	Sinking Switch #1 (note 3) OR Sourcing Switch #1
White	Output #2 (note 1) 0-10 VDC (note 3) OR Sinking Switch #2 OR Sourcing Switch #2 OR OFF	Sinking Switch #2 (note 3) OR Sourcing Switch #2
Green	These wires are not on ToughSonic 3, 12, or 14 Sensors	Current sourcing output
Orange		Current sinking output
Violet		Voltage output
Notes: (1) Output selection for the black and white wires of ToughSonic 3, 12, or 14 sensors are made via SenixVIEW (page 45) (2) Output determined by sensor model. The gray and yellow wires are also used for synchronization (page33) (3) Factory default selections (can be changed using SenixVIEW)		

Table 1 - Wire Assignments

Tinned ends are standard. Connectorized cables are also available, as are other cable lengths.

Ground (blue wire)

The ground wire is common to both the power supply and the output circuits.

Cable Shield (bare wire)

The cable shield is not terminated at the sensor. This wire should be terminated to equipment ground near the user equipment, preferably to a single point ground for all equipment. This is important if the cable is lengthened and/or routed near electrically noisy wiring or equipment.

Power Input (brown wire)

Connect a DC power supply to the DC+ (Brown) and GND (Blue) wires. These colors conform to EU standards. Reversing the power connections will not damage the sensor. A power supply voltage between 15-30 VDC is recommended. A +24 VDC supply is a commonly used standard. Target sensitivity and the maximum voltage output value is reduced at power supply voltages below 15 VDC. When power is applied, the rear LED *target indicator* will light and the sensor operates as described on page 31.

ToughSonic 3, 12, &14 Outputs (black & white)

Each output can be either an analog, a switch, or turned OFF. Analog interfaces are described on page 21 and switch interfaces on page 23. Output selections require SenixVIEW (see page 45).

ToughSonic 30 and 50 Outputs

These models provide simultaneous 0-10 VDC, 4-20 mA sourcing, 4-20 mA sinking, and two switch outputs. The default switch outputs are sinking (NPN type) but may be changed to sourcing (PNP type) or turned OFF using SenixVIEW.

Data Connections (gray & yellow)

Serial data interfaces are described on page 26. They are used for:

- SenixVIEW PC configuration (page 45)
- Synchronization (page 33)
- User communications between the sensor and an external data communications device

All ToughSonic serial RS-232 models can connect to a PC USB port for SenixVIEW configuration as shown in figure 9 with UAN-KIT-USB-232 and optional UA-USB-232-ISO adapter,. See Software and Interconnection (pg 15).

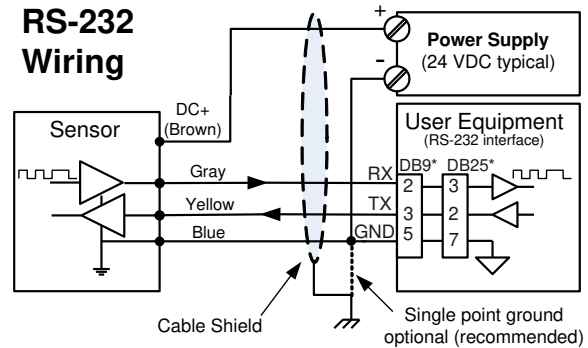

* Typical personal computer connections for 9 and 25-pin serial COM connectors

Figure 9 - RS-232 PC COM Port Connections

RS-485 models require the RS-485 interface kit, UAN-KIT-USB-485 and UA-USB-485-ISO adaptor for USB port connection, or the full kit UAN-KIT-USB-485. See Software and Interconnection (pg 15).

ToughSonic 3, 12, &14 Output Selection

The ToughSonic 3, 12, &14 series sensors have two user-selected outputs. These outputs connect via the black and white wires of the sensor cable.

The factory default selections are a 4-20 mA current loop connected to the black wire and a 0-10 VDC output to the white wire. Using SenixVIEW, one or both of these analog outputs can be changed to either a sinking (NPN) or sourcing (PNP) switch, or can be turned off. If turned off the associated rear status indicator is also turned off.

Refer to Outputs & Indicators on page 45 for information on using SenixVIEW.



Make the output selections before connecting the sensor to equipment!



Output selections are not affected by a TEACH 17 reset.

NOTE: Output selection is NOT REQUIRED for ToughSonic 30 and 50 series sensors. All outputs are independently wired and simultaneously run.

Analog Outputs

ToughSonic 3, 12, 14 Analog Outputs

The above sensors have these analog outputs:

- Voltage and sourcing current loop outputs
- Output selection is accomplished using SenixVIEW (page 45). Defaults are I and V.

ToughSonic 30, 50, and 50P Analog Outputs

These sensors have three analog outputs - voltage, sourcing loop and sinking loop. They are simultaneously available on separate wires and do not require selection using SenixVIEW.

Analog Status Indication

Rear status indicators show whether the analog output is at the high value, low value or between those values as shown in Figure 8 - Output Status Indicator Operations.

Voltage Output

This figure shows a voltage output connection:

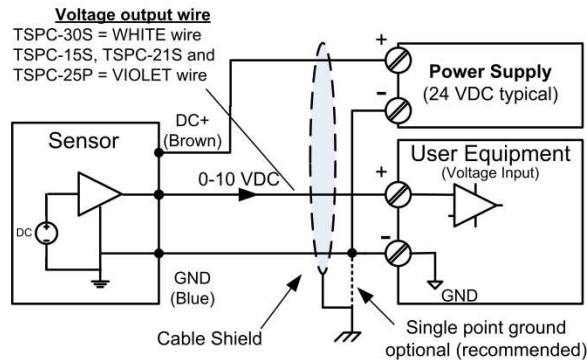

Figure 10 - Voltage Output Wiring

The default voltage output is a 0 to 10 volt DC signal proportional to the measured distance between the endpoints set by the user. The voltage range can be changed to 0-5 VDC using the TEACH 30, or can be set to a custom output range with values between 0 and 10 volts using SenixVIEW (see i & j below). The analog slope can increase or decrease with distance but all analog outputs must have the same slope. The voltage is measured relative to GND (BLUE wire). The 0 and 10 volt endpoint distances affect both voltage and current loop outputs, and can be set anywhere in the sensor's operating range using the TEACH button or SenixVIEW.

Sourcing Current Loop Output

This figure shows a sourcing current loop connection:

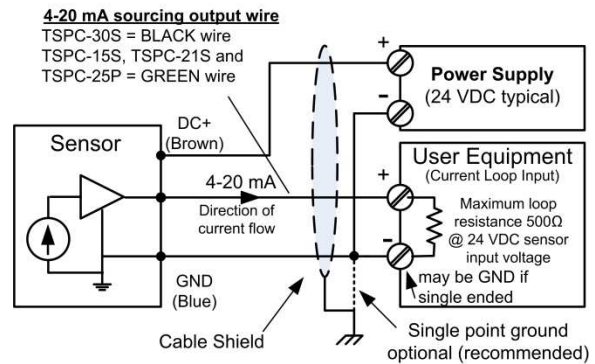

Figure 11 - Sourcing Current Loop Wiring

The default sourcing loop output is a 4 to 20 mA signal proportional to the measured distance between two endpoints set by the user. The current range can be set to any values between 0 and 20 mA using SenixVIEW (see d & e in Figure 13). The slope can increase or decrease with distance but all analog outputs must have the same slope. In a sourcing loop current flows out of the sensor, through the user equipment and back to the sensor GND (BLUE wire).

Sinking Current Loop (orange wire)

This output is NOT available in the ToughSonic 3, 12, and 14 series.

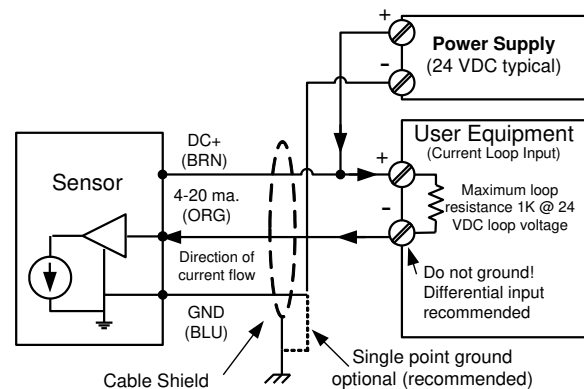

Figure 12 - Sinking Current Loop Wiring

The default sourcing loop output is a 4 to 20 mA signal proportional to the measured distance between two endpoints set by the user. The current range and slope are SenixVIEW adjustable and identical to that set for the sourcing loop described above. Current flows from the power supply through the user

equipment then INTO the sensor (ORG wire) as shown in Figure 12.



The analog inputs of User Equipment in Figure 12 are either differential (both + and – terminals) or single ended (+ and GND terminals). A differential input is recommended at the user equipment. If the user equipment is single ended (+ input and GND) the sensor and user equipment cannot share a common ground or the current loop will not work.

Analog Teach Adjustments

The following analog adjustments can also be accomplished using the TEACH button where equipped (page 52):

TEACH 4: Analog Low Endpoint (b above)

TEACH 5: Analog High Endpoint (c above)

TEACH 30: Set voltage range to 0-5 VDC (d & e)

TEACH 31: Set voltage range to 0-10 VDC (d & e)

TEACH 35, 36, 37: no target response (h)

TEACH 17: Resets all factory defaults

After teach adjustments are performed SenixVIEW can be used to display and/or save the new configuration. The TEACH button may be disabled in SenixVIEW to prevent unwanted changes.

Endpoints and Slope

The voltage and current loop(s) are spanned between the same two *endpoint* distances (see b & c in Figure 13). *Endpoints* can be set anywhere in the sensor's *operating range* using the TEACH button or SenixVIEW.

All analog outputs must have the same slope, i.e., increase or decrease in value in proportion to distance. The high and low output values (voltages and currents), however, are independently adjustable in SenixVIEW for voltage and current loops.

Response Time

Analog response time is affected by measurement rate and filter selections (pg.37).

Analog Displays

The sensor's calculated analog output values are shown in real time on the SenixVIEW meter displays (page 35).

SenixVIEW Analog Adjustments

Use SenixVIEW to tailor the sensor for best results in the application. Analog features are shown in Figure 13. The letters used below are keyed to that figure:

- a) Click the **Workspace** icon to edit parameters
- b) *Low Endpoint:* Click the numeric value to set the distance of the low analog values (e).
- c) *High Endpoint:* Click the numeric value to set the distance of the high analog values (d).



The analog slope will automatically reverse if the Low and High Endpoint distances (b & c) are set in reverse order

- d) *High Value:* Click the numeric value to change the maximum voltage or current value. The voltage and current limits are independent.
- e) *Low Value:* Click the numeric value to change the minimum voltage or current value. The voltage and current limits are independent.
- f) Click the **Analog** icon for additional features.
- g) Select the output values set at power-on. These values exist until the first *measurement process* is completed.
- h) Select the output values to be set if no target is detected in the *Operating Range* (j to k).
- i) If this sensor is a synchronized slave (page 33) select the output values to be set if the master SYNC input is missing. These selections are grayed out if the sensor is not a slave.
- j) *Range MIN:* The closest distance the sensor will measure distance (see page 34).
- k) *Range MAX:* The farthest distance the sensor will detect a target (see page 34).

All sensor parameters are described in on page 52.

Workspace parameter changes must be saved to the sensor to take effect, and can also be saved to disk for later recall as described on page 43.

ToughSonic® Family Sensors – Installation & Operating Instructions

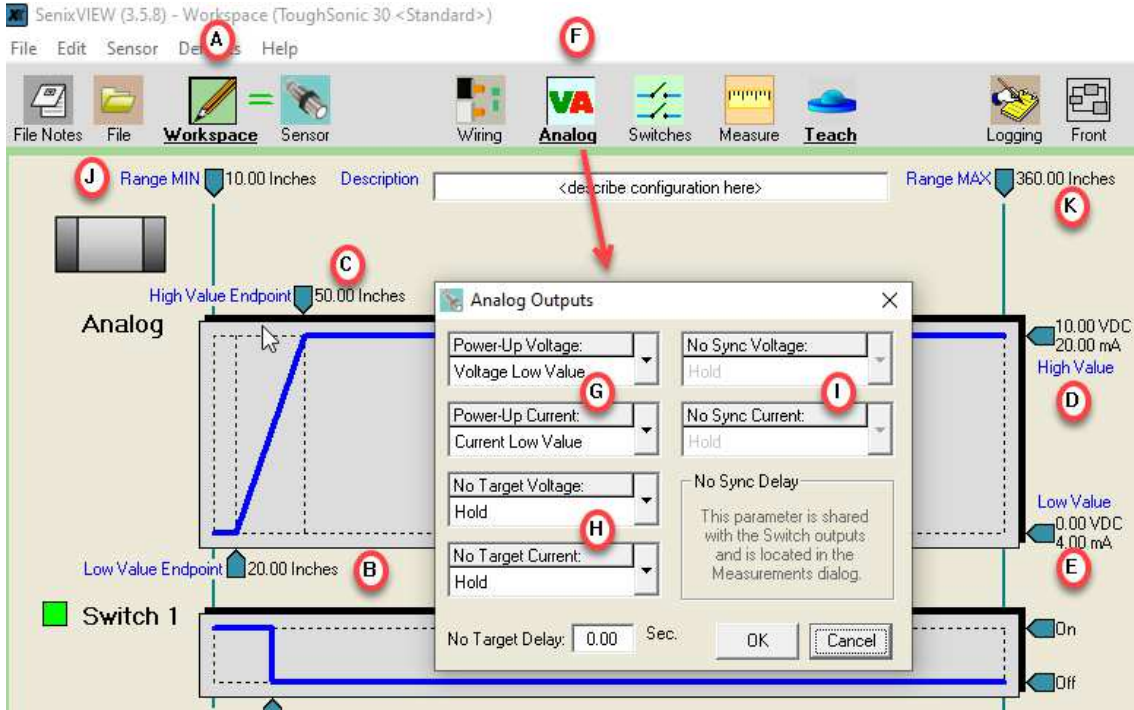

Figure 13 - SenixVIEW Analog Adjustments

Switch Outputs

ToughSonic sensors have two solid-state switch outputs. In ToughSonic 3, 12, and 14 series sensors the switch outputs must be selected using SenixVIEW. If selected, switch #1 is on the black wire and/or switch #2 is on the white wire. In all other models they are permanently wired to the black and white wires as NPN type. In all models the switch type can be selected as either sinking (NPN), sourcing (PNP) or OFF using SenixVIEW (page 45).

Switch Status & Output Voltage

Switch outputs normally have a corresponding rear *output status* indicator (■ = #1, ▨ = #2) that is lit when the switch is ON and vice versa. The indicators also provide warning of a safe shutdown under overload or over temperature conditions. They can, however, be reassigned using SenixVIEW. When a sinking switch is ON the voltage of the switch wire will be near 0 VDC, and when OFF will be near the voltage of the external “pull-up” source. When a sourcing switch is ON the voltage of the switch wire will be near the sensor’s power supply voltage and when OFF will be near 0 VDC.

Sinking Switch Output

Typical PLC Input (DC)

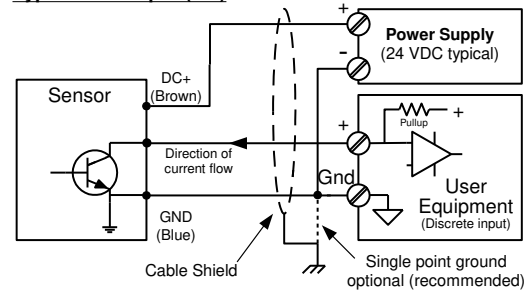

Other Typical Uses

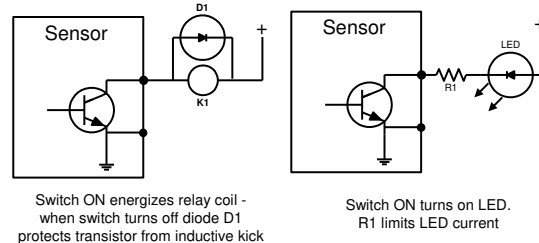

Figure 14 - Sinking Switch Output Wiring

A *sinking switch* is an open collector transistor (solid state switch) that sinks current through an external

load to GND when ON. The external device can be powered from a source different from the sensor.

Sourcing Switch Output

Typical PLC Input (DC)

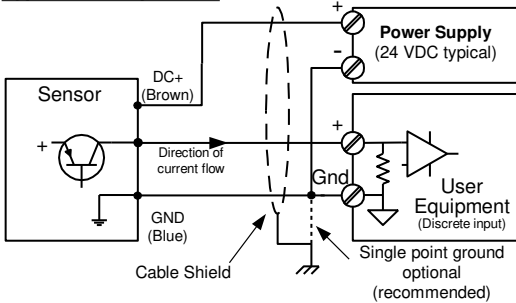

Other Typical Uses (power & GND not shown)

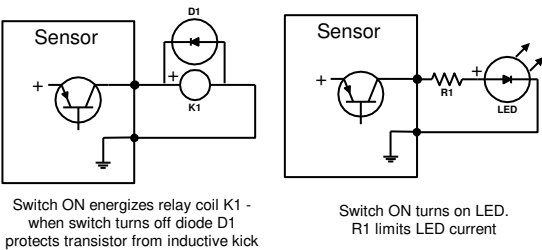

Figure 15 - Sourcing Switch Output Wiring
A sourcing switch provides current to an external load to turn that load ON or OFF as shown in Figure 15. Current is sourced by the sensor's power supply.

Switch Response Time

Switch response times are affected by measurement rate and filter selections (pg. 40).

Switch Displays

The sensor's calculated switch output states are displayed in real time in SenixVIEW (page 35).

Switch TEACH Adjustments

Switch adjustments can be accomplished using the TEACH button (page 52) in the ToughSonic 3, 12, 14, and 30 series sensors. Each switch setpoint and polarity can be changed, and the no target delay can be turned on or off.

After teach adjustments are performed SenixVIEW can be used to display and/or save the new configuration.

SenixVIEW Adjustable Switch Features

Basic and extended features assure optimum system settings and control functions that otherwise require external logic or time delay relays. Each switch has the following configurable features:

- Setpoint (ON switching distance)
- Polarity (ON closer or farther than setpoint)
- Mode = Setpoint (with Hysteresis) or Window (see Figure 16)
- ON and OFF time delays for state changes
- No Target state and time delay
- Power-up state
- No SYNC states

ToughSonic® Family Sensors – Installation & Operating Instructions

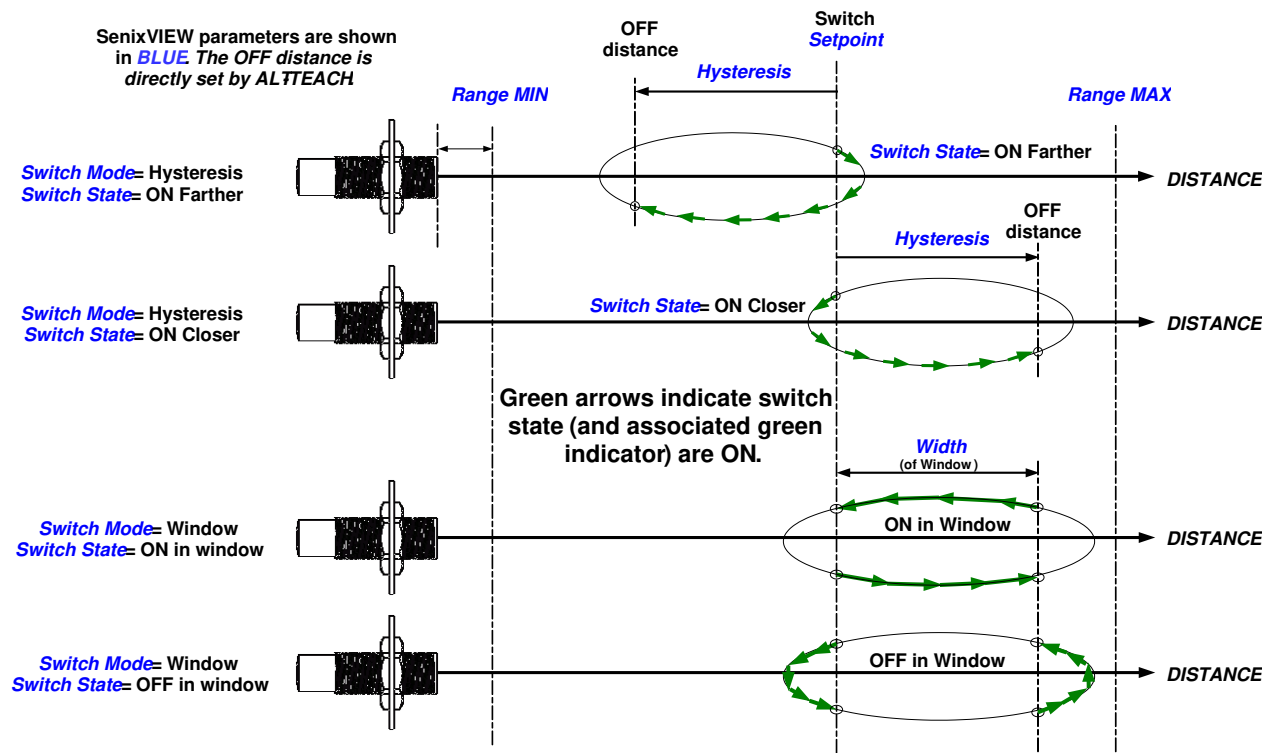

Figure 16 - Switch Hysteresis & Window Modes

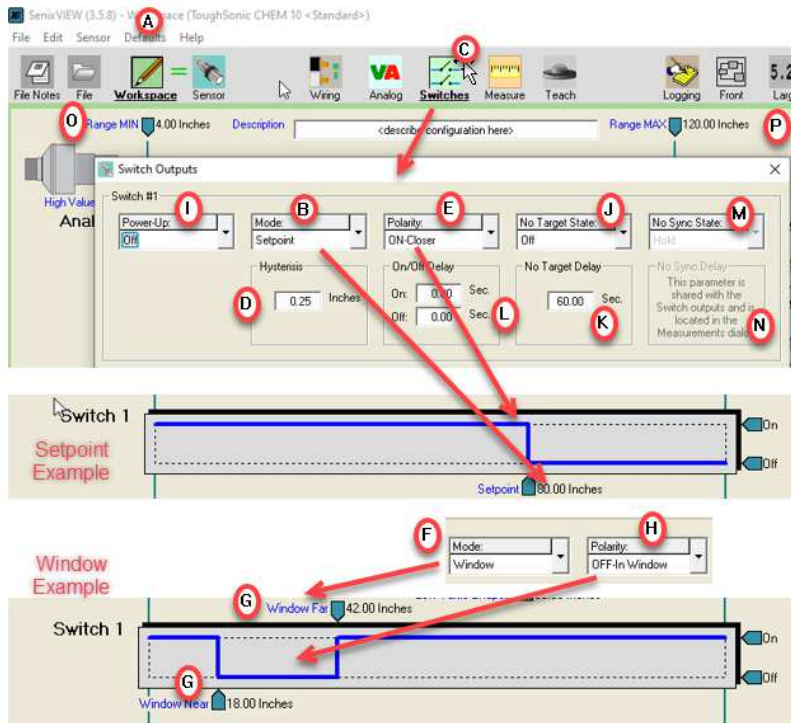

Figure 17 - SenixVIEW Switch Adjustment

SenixVIEW Switch Adjustments

Use SenixVIEW to tailor the sensor for best results. Switch features are shown in Figure 17. The letters used below are keyed to that figure:

- a) Click the **Workspace** icon to edit parameters
- b) *Setpoint*: Click the numeric value to set the distance where the switch turns ON (the switch turns OFF by reverse hysteresis distance (d))
- c) Click the **Switches** icon for additional features.
- d) Hysteresis is the distance the target must move in the reverse direction of the Setpoint to turn OFF.
- e) The polarity can be either ON CLOSER or ON FARTHER than the *Setpoint*. This is like setting a normally open or normally closed condition.

Reversing the switch polarity also reverses the hysteresis (d) direction!



- f) **Window** is an alternate mode where the switch state is *Polarity* (h) inside the window (over a range of distances) and the reverse if outside.
- g) Click these numbers to enter the window **SIZE**. The size is added to the setpoint to become the *window far distance*.
- h) The *Polarity* can be either ON or OFF for targets within the window. This example shows OFF
- i) Select the switch state to set at power-on. This state exists until the first measurement process is completed.
- j) If the sensor loses the target the state can be **held** or set **on** or **off** (after delay k).
- k) If the sensor loses a target for this time period the no target state (j) is set. (0= immediate)
- l) Time delays can be required before turning a switch on or off. A switch state is set if a target continuously satisfies that state's requirements for the full delay time period.
- m) If this sensor is a synchronized slave (page 33) select the output state to set if the master SYNC input is missing (**on**, **off** or **hold**, and after time delay (n)). These selections are grayed out when the sensor is not a slave.
- n) If the sensor is a synchronized slave, a time delay can be required before engaging the No Sync response (m). This delay is set in the **Measure** dialog since it also affects the analog outputs.
- o) *Range MIN*: The closest point the sensor will measure distance (page 34).
- p) *Range MAX*: The farthest distance the sensor will detect a target. See page 34 for a detailed description of the sensor *Operating Range*.

Serial Data Interface

The YELLOW and GRAY serial data communications wires are used for three purposes:

1. **Setup** – Connect to a PC running SenixVIEW™ software for setup, calibration, analysis, and rapid sensor cloning.
2. **User Applications** – Connect to an external system and provide distance measurement data. Several operating modes are available.
3. **Synchronization (SYNC)** – Time synchronize a group of 2-32 sensors (see page 33).

The electrical interface can be RS-232 or RS-485:

- Models ending in 232 are RS-232
- Models ending in 485 are RS-485
- All models are RS-485 in SYNC modes

RS-232 (PC COM Port)

Serial RS-232 models use a serial data RS-232 interface directly compatible with a PC COM port. The PC COM wiring is shown in Figure 18.

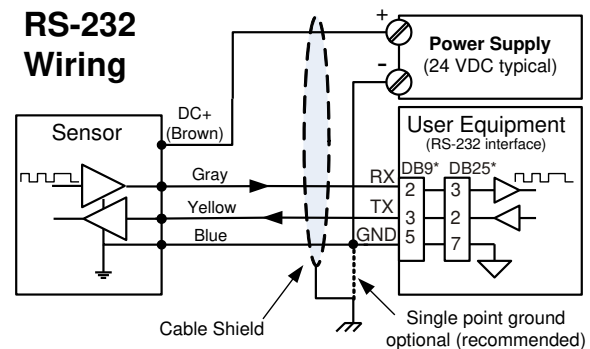

* Typical personal computer connections for 9 and 25-pin serial COM connectors

Figure 18 - RS-232 PC COM Port Connections

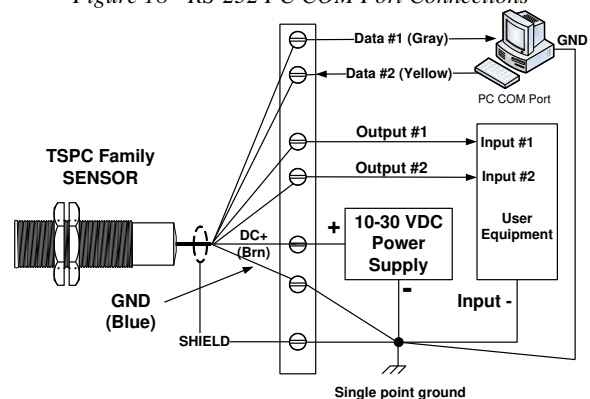

Figure 19 - RS-232 Connections

RS-485 (Multi-Drop Addressable)

Serial RS-485 models use a serial data RS-485 interface that can be used over long distances. Up to 32 addressable sensors can be connected to the bus. A single sensor is shown below connected to an RS-485 port. To use SenixVIEW with these models the PC must have an RS-485 adapter connected. Adapters are available to convert COM or USB ports to RS-485.

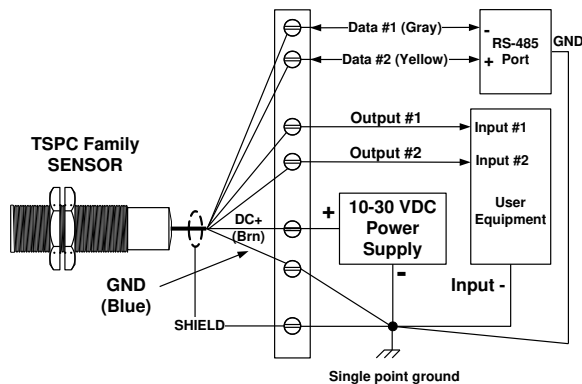

Figure 20 - Serial-485 Connections

Sensor Networks (RS-485)

ToughSonic sensors can be configured into RS-485 addressable multi-drop networks as shown below.

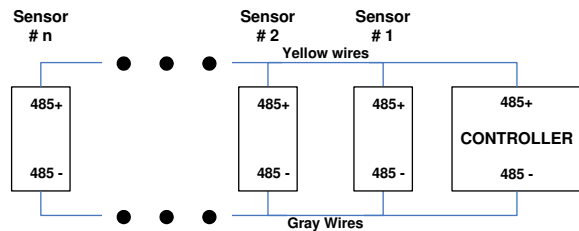

Figure 21 - RS-485 Network Wiring

Before connecting to a network each sensor must be assigned a unique address and all sensors must be configured to the baud rate of the network controller, as described in following. The address assignments must also be different from other connected (non-Senix) devices.

Sensors used in an RS-485 network must be configured in *continuous* or *start-on-poll* measurement activation depending on the needs of the system (page 31). Sensors used in a SYNC group must be configured with one SYNC master and the rest as slaves.

Serial Parameters

The default parameters are 9600 baud, no parity, one stop bit (8N1), and sensor address 1.

Baud Rate Options

The baud rate is SenixVIEW adjustable to 9600, 19200, 38400, 57600 or 115200 baud. The slower 9600 baud rate is recommended for best performance over longer cables. The 115200 baud rate is only available if measurement activation is “Start on Poll”. The selected baud rate is used for all protocols (Modbus, ASCII streaming and SYNC).

Parity

The default parity is “none”. Sensors with V27 firmware or later will automatically change parity to even based on the incoming packet. One packet error will occur, then the sensor will operate on even parity.

Sensor Address

The default sensor address is 1. The address is SenixVIEW adjustable from 1 to 247. SenixVIEW requires a correct sensor address to establish a connection. In general, leave the address at 1 unless using the sensor in a network. Each sensor being connected to a multi-sensor addressable network must first be assigned a unique address. Sensors with the same address will conflict and appear non-functional. Addressable multi-sensor networks are only possible with an RS-485 interface (requires serial RS-485 models).

A unique address is not required for SYNC groups, however, a SYNC group can also be an addressable network when the SYNC Master is turned off. SenixVIEW includes a *Group Control* feature to disable the SYNC Master to allow sensor reconfiguration and/or monitoring, then re-enable the Master and resume.

Changing Communications Settings

A single sensor in the factory configuration, wired to either an RS-232 or RS-485 interface, connects to SenixVIEW using the default serial parameters.



*Serial data parameters are not affected by selecting the factory default configuration (menu: **Workspace – Default Settings**, or **TEACH-17**)*

If multiple sensors are connected into an RS-485 network each must be assigned a unique network

ToughSonic® Family Sensors – Installation & Operating Instructions

address. The baud rate and address are changed in SenixVIEW as:

1. Connect to the sensor (menu: **Sensor – Connect**), described on page 43.
2. Select the communications parameters (menu: **Sensor – Communications**) and see:

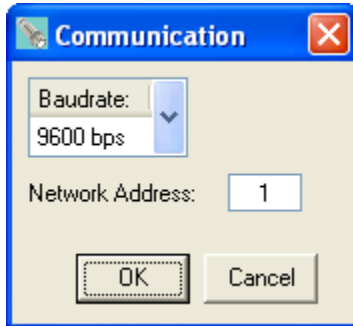

3. Select a different baud rate, or enter a unique address from 1 and 247, then click OK and see:

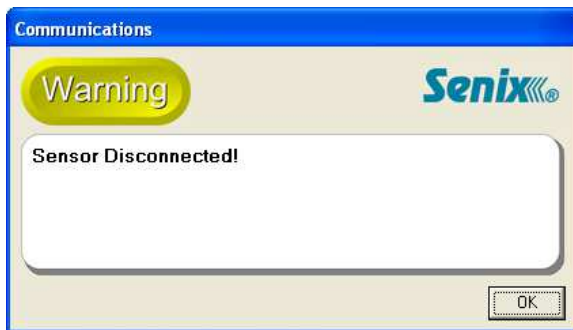

4. The sensor will now connect (menu: **Sensor – Connect**) only using the new parameter values.
5. All sensors must use the same Baudrate.

SenixVIEW Network Connect

SenixVIEW is fully functional when connected to a single ToughSonic sensor on an RS-485 network (menu: **Sensor – Connect**). Simply enter the correct baud rate and network address to establish the connection.

SenixVIEW Group Control

SenixVIEW can update selected parameters quickly to a group of RS-485 connected sensors using menu: **Sensor – Group Control**. When Master Synch is turned OFF (lower left), the group is scanned and a list of connected sensors produced. Selected parameters can then be written to selected sensors.

First, enter the parameter values to transfer into the Workspace, disconnect the current sensor, and then select menu: **Sensor – Group Control** to produce the following control dialog:

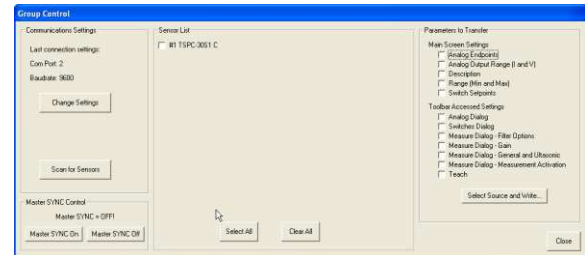

Click Scan to initiate a sensor search of all network addresses. Master Synch must be OFF to search. Use the buttons in the lower left of the dialog to control the Master Synch. Up to 32 found sensors will be listed in the center display area with (a) a check box, (b) the model number and (c) the activation mode (C=continuous, P=start on poll, Mx=master x phases, Sx=slave phase X). The check boxes can be individually selected, all checked using *Select All*, or all cleared using *Clear All*. The “Parameters to Transfer” section on the right side lists parameter collections that can be selected for upload to all checked sensors. Check the desired collection(s) then click *Write* to begin the batch transfer.

Group operations require SenixVIEW to operate as the bus Master. Any other bus master must first be disabled or disconnected.

SYNC Group

Regardless of the model, when ToughSonic sensors are connected in a SYNC group (page 33) the communications interface operates as RS-485. With an RS-485 connection, SenixVIEW can communicate with the sensors using **Group Control** (above). In a SYNC group one sensor operates as a master control. The master must be shut down before SenixVIEW can take control. SenixVIEW will automatically detect an active SYNC master and provides the following indication and controls:

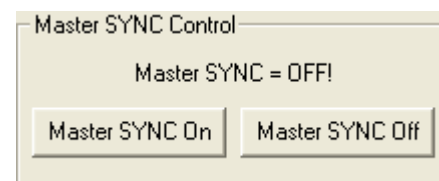

If a Master is detected, click “Master SYNC off” then confirm the status as “No Active Master!” to enable

the **Group Control** features. When finished, click “Master SYNC On” to restore SYNC operation.

31H - 0DH. This number represents a count value proportional to the detected target distance (except 00000 which means no target was detected).



First determine and select sensor outputs using SenixVIEW (page 45) before connecting the sensor to equipment!

Serial Data Protocols

ToughSonic sensors offer these protocol options:

1. **Modbus Slave** – This default protocol is used by SenixVIEW and supports sensor communications by address, typically in RS-485 networks.
2. **ASCII Streaming** – A simpler continuous ASCII protocol for one-way transmission of data to external devices (page 29).
3. **SYNC** – SYNC master and slave sensors use the serial interface for synchronization (page 33).

Modbus Protocol

The ToughSonic sensors and SenixVIEW use the industry standard Modbus RTU protocol for all serial data bus communications except SYNC. Other user controllers can use this interface to obtain distance measurements, switch and analog status, temperature, Target quality, and scale factors. Request document *ToughSonic Serial Communications Formats*. A brief description follows.

The sensor determines distance in Counts which are held in registers and used by SenixVIEW or the user’s own program. A register is now available that shows the current measurement in millimeters regardless of sensor model, product ID, or scale factor.

ASCII Streaming Protocol

A Senix ASCII protocol is also available that transmits an ASCII string after each measurement under continuous measurement activation. This can be used for input to displays or other devices. Use SenixVIEW to enable this protocol in menu item **Sensor > Connect > Advanced features** to switch between ASCII streaming and Modbus protocols. After each measurement or measurement process the sensor transmits five ASCII numbers terminated with a carriage return. For example, 05261 <CR>, or in equivalent hexadecimal: 30H - 35H - 32H - 36H -

ToughSonic® Family Sensors – Installation & Operating Instructions

The user equipment can either display the ASCII data directly, such as viewing the output data on Windows Hyperterminal or TelNet, or calculate distance by converting the data to binary and multiplying by a scale factor. The scale factor varies with the sensor series. The scale factors at 69 degrees F (or with temperature compensation enabled) for each sensor series are shown below in the Scale Factor table. :
 For example, if the count value from a TS 14 sensor is 05251, the distance is calculated as $5251 \times 0.003384 = 17.77$ inches.

Polling the sensor for data

A user can obtain data directly from sensor holding registers using Modbus RTU commands. Writing to sensor registers directly is discouraged in favor of using SenixVIEW to make configuration changes. Request document *ToughSonic Serial Communications Formats* for more information.

MODBUS Registers Available

Available registers on all ToughSonic sensor models.

Hex Address	Field
0x0220	Raw Counts
0x0221	Filtered Counts
0x0222	Millimeters
0x0223	Temperature **
0x0224	User Target Width (counts)
0x0225	Reference Target Width (counts)
0x0226	Reference Target Distance (counts)
0x0227	Scale Top
0x0228	Scale Bottom ***

** $(C * 10)$ (i.e for 33.5 °C it will show 335)

***Where Scale Top / Scale Bottom = 0.003384 for a TS14. This lets the user read the conversion factor

Reading any of these registers will cause the sensor to take a measurement in Start On Poll activation mode.

The following registers may be read either as single registers or as a group:

Hex Address	Field
0x0208	Distance Field
0x0209	Cycle Count
0x020A	Voltage
0x020B	Current
0x020C	Sensor Temperature
0x020D	Switch States
0x020E	Unfiltered Distance

Product IDs

Senix products hold product ID in register 0x0800.

Product ID	Sensor
1000	ToughSonic 14
2000	ToughSonic 3
3000	ToughSonic 30
4000	ToughSonic 50
1001	ToughSonic CHEM 10
3001	ToughSonic CHEM 20
4001	ToughSonic CHEM 35
4002	ToughSonic 50P
6000	ToughSonic LONG 72
1002	ToughSonic 14 Serial only
3002	ToughSonic 30 Serial only
4003	ToughSonic 50 Serial only

Scale Factors

Sensor type	in/ct	ft/ct	mm/ct	cm/ct
T3,T12,T14, L100	0.003384	0.000282	0.085954	0.008595
T30, L300	0.006768	0.000564	0.171907	0.017191
T50, L500	0.013536	0.001128	0.343814	0.034381

Operation

Power Up

The following occurs within 1200 ms of power ON:

- Target indicator set to RED
- Outputs and their status indicators set to their power-up states (SenixVIEW selected)
- Sensor begins first measurement or becomes available for *slave* or *start-on-poll* activation
- The analog and switch outputs are set, and distance data becomes available, after completing the first measurement process

All sensor outputs and status indicators remain in their power-up conditions until the first *measurement process* has completed.

Measurement Activation

Sensor measurements can be activated in four ways – *continuous*, *start-on-poll*, *master* and *slave*. The factory default and most common is *continuous*. The activation options are set using SenixVIEW by clicking the **Measure** icon then using the Measurement Activation selector (Figure 22).

Master, *slave* and *continuous* activation selections are also TEACH selectable in certain models (page 50) except in *start-on-poll* mode.

Sensor features affected by the activation mode are summarized in Table 2 below. Refer to the *measurement process* definition on page 34.

Measurement Activation Mode Selected	When the Measurement Starts	• Features Allowed							When the Analog and Switch outputs are updated	Serial Data Bus (RS-232 or RS-485)
		TEACH	Filters							
			X of Y	Closer of M	Farther of M	Averaging	Rate of change	Slow-Fast		
Continuous (factory default)	Repetitively at the <i>measurement interval</i>	•	•	•	•	•	•	•	After each measurement or <i>measurement process</i>	Last <i>measurement process</i> distance sent in response to distance poll
Start on Poll	Distance poll received (& current <i>measurement process</i> finishes)			•	•	•			After the measurement or <i>measurement process</i> triggered by the distance poll	Last <i>measurement process</i> distance sent in response to distance poll
SYNC Master	Repetitively at the [<i>measurement interval</i> * <i>SYNC phases</i>]	•	•	•	•	•	•	•	After each measurement	Sends SYNC commands (distance not sent)
SYNC Slave	Upon receiving a master SYNC command.	•	•	•	•	•	•	•		Receives SYNC commands (distance not sent)

Table 2 - Measurement Activation Summary

Activation Selection

Click the SenixVIEW **Measure** icon then locate the following Measurement Activation drop down menu:

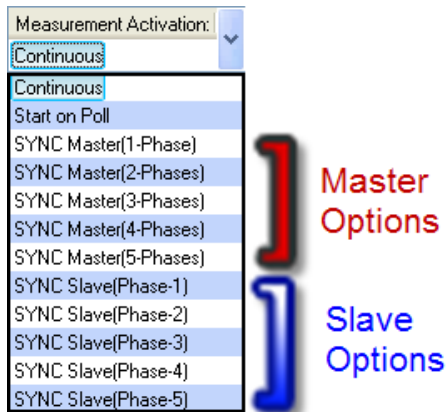

Figure 22 - Measurement Activation Selections

Continuous Activation

This is the factory default. Measurements repeat continuously at the *measurement interval*. The analog and switch outputs are updated, and the distance data is stored, at the end of each *measurement process*. At any time a serial data controller can retrieve the last stored distance data by issuing a serial data read poll without effecting ongoing measurements. Continuous mode is generally used unless:

- There is an advantage to having the sensors measure only on request (see Start on Poll)
- Multiple sensors are connected in a synchronized group (see SYNC modes)

SenixVIEW will detect this mode when the **Sensor** icon is clicked, then repeatedly issue read polls to display the distance measurements.

Start on Poll Activation

Measurement begins when the sensor receives a serial data distance read poll from an external controller (or SenixVIEW). Upon completing the *measurement process* the analog and switch outputs are updated, the distance measurement stored, and the sensor stops measuring. The data retrieved by the poll is that of the prior distance measurement.



TEACH and several filters are disabled in Start on Poll activation (page 31).

SenixVIEW detects start-on-poll mode when the **Sensor** icon is clicked, and displays polling controls in the upper right corner of the screen (Figure 23).

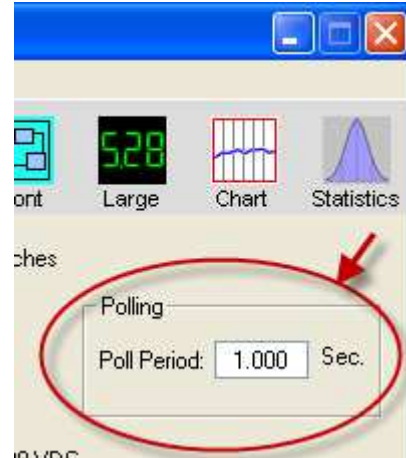

Figure 23 - SenixVIEW Polling Controls

SYNC Master and Slave Activation

Synchronization (SYNC) is an interconnection of one *Master* sensor and one or more *Slave* sensors in a group (page 33), often used to prevent sensor crosstalk in close setups. Using the Measurement Activation drop down menu shown in Figure 22 configure one master to the desired number of *SYNC phases*, and each slave sensor to its required phase. The master's serial data interface is used only to control slave sensor timing and no distance data is transmitted or available to SenixVIEW. Sensor analog and switch outputs continue normally in SYNC mode, including from the master.



Hints & Recommendations:

- Setup and test each sensor in SenixVIEW before selecting SYNC and connecting it to the SYNC group.
- After setting SYNC activation, ToughSonic serial RS-232 slave models lose communications with the SenixVIEW PC because the serial interface changes to RS-485. To restore communications, disconnect the sensor from the SYNC group, use TEACH 15 to turn SYNC off, and reconnect to the PC using RS-232 equipment.
- With an RS-485 PC connection, SenixVIEW can communicate with an operating SYNC group using the **Sensor – Group Control** menu selections. To allow this ability each sensor in the group must be assigned a unique network address (**Sensor – Communications** menu) before connecting it to the SYNC group.

Synchronization

Groups of 2 to 32 sensors can be connected together and time synchronized for these purposes:

- Prevent sensors in close proximity from interfering with one another (“cross-talk”)
- Enable a group of sensors to measure a common target(s) at the highest possible rate

The symptom of sensor interference is an output (*analog or switch*) jumping intermittently but usually somewhat periodically to a value or state representing a target closer to the sensor than the actual target. This symptom may disappear or be less severe when filters are used (pg. 38). If interference is suspected, turn power off to all but one sensor to determine if the powered sensor’s output stabilizes (keep filters off).

A SYNC group is created by connecting together all yellow wires of all sensors, then all gray wires of all sensors, as shown below (the power, analog and/or switches are wired as required for the application). One (and ONLY one) sensor is then defined as Master and all others as Slaves.

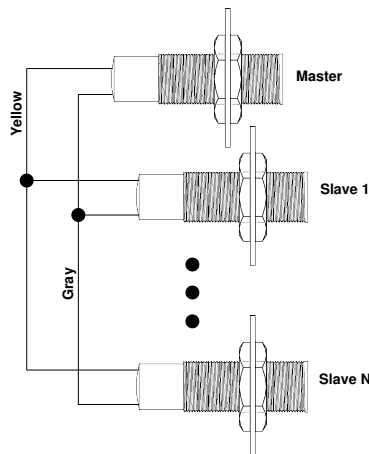

Figure 24 - SYNC Wiring

Master and slave assignments can be set in advance in the SenixVIEW *Measure* dialog (pg. 32), or after they are wired using the TEACH pushbutton (pg. 50) on certain models. SenixVIEW must be used to (a) set a master to generate 1, 3, 4 or 5 *SYNC* phases (the default is 2), or (b) to set a slave to phase 3, 4 or 5 (see following).

Master sensors cannot communicate with SenixVIEW until *Group Control* or TEACH 13, 14 or 15 turns off the master. However, analog and switch outputs remain active on all sensors in SYNC mode grouping. Group Control is found in SenixVIEW under the Sensor pull-down menu.



Master measurements repeat continuously at the *sync interval* which is the *sync phases x measurement interval* (see figure below). Slave measurements are similarly affected but offset in time according to their phase assignment (1 through 5). The *sync interval* increases as the number of *sync phases* increases, therefore slowing the *measurement process* timing for all sensors in the group.

With a master in 1-Phase and slaves in slave phase 1 all sensors operate simultaneously as shown in 1 phase below. When the master is in 2 through 5 phases, each slave must be set for phase 2, 3, 4, or 5. Do not set a slave phase higher than the number of phases of the master or it will not operate.

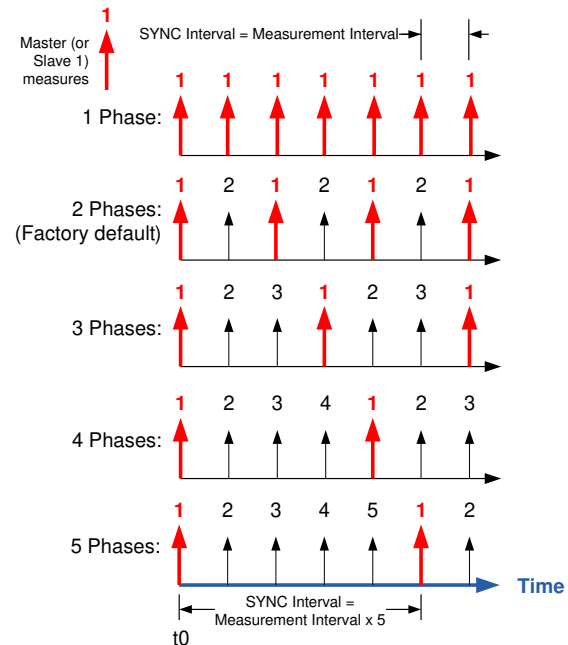

Figure 25 - SYNC Phases and Timing

The SYNC connections use the sensor’s *serial data* interface to control sensor timing and serial distance data is not available.



SYNC and serial data communications cannot occur simultaneously. Removing the master re-enables communications.

If the master input is missing the slave sensors stop measuring, begin flashing the *target indicator* red-green as a warning (pg. 17), and after the *no sync delay* time set analog outputs to their *no sync values* and switch outputs to their *no sync states*. These conditions reverse when SYNC is reestablished.

Operating Range

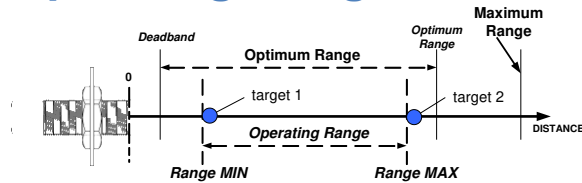

The sensor measures the distance to targets within the *Operating Range* (target 1 to target 2). This range can be set in SenixVIEW by adjusting the *Range MIN* and *Range MAX* parameters. The factory default is the widest possible, *deadband* to *maximum range* (see specifications, page 8).

Range Min

The *Range MIN* (also called *Deadband*) is the closest distance that the sensor will report an accurate distance (see Specifications). Targets closer than *Range MIN* may be detected, especially at close range, but the measured distance will be *Range MIN* (or greater for secondary echoes). If the near distance is important keep the target beyond *Range MIN*.

Range Max

The *Range MAX* is the farthest distance that the sensor will detect a target. Targets farther than *Range MAX* are ignored. If a target is not detected closer than *Range MAX* a “No Target” condition exists.

Under “No Target” conditions the analog and switch output values or states can be configured to either hold their prior or set specific values or states, either immediately or after adjustable time periods.

The “No Target” controls can be an important and useful tool to control system response by limiting the distance the sensor will consider a target valid.

Factory Defaults

The factory default range values are:

- Range MIN = deadband
- Analog far setpoint = Optimum range
- Range MAX = Maximum Range

Measurement Process

The *measurement process* includes the raw distance measurement, followed by one or more filter options (page 38), then any switch time delays (page 41) before the result is reflected in the sensor outputs.

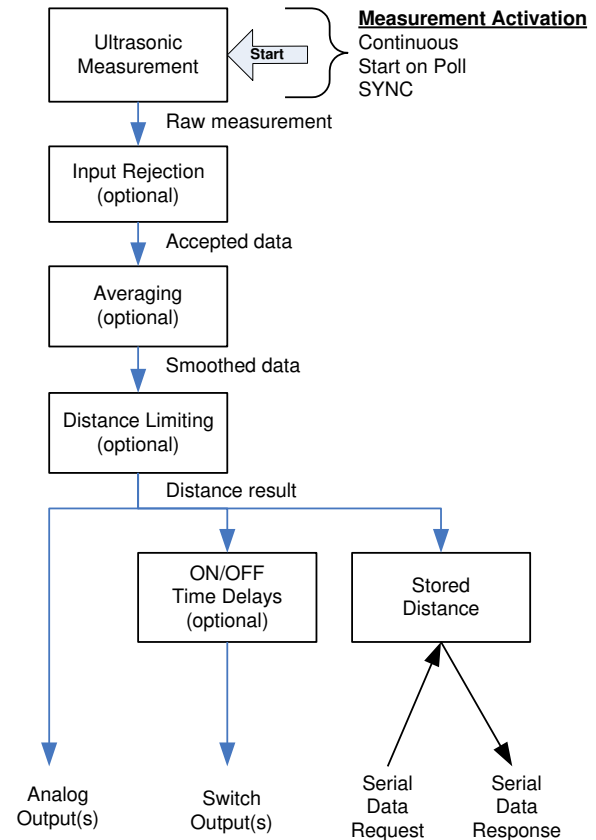

Figure 26 - Measurement Process Diagram

In Start on Poll activation the entire process is performed once per poll, i.e., M Input Rejection x N Averaging measurements (page 40). Some filters are disallowed in Start on Poll (page 31). If a poll is received before an ongoing *measurement process* finishes, the ongoing process will run to completion then another *measurement process* will begin.

Switch time delays can be set to implement special control functions. The most recent distance result can also be requested by an external controller over the serial data bus (page 29).

Sensor Viewing

When connected to a sensor (**Sensor** icon clicked), distance measurements are viewed in SenixVIEW in several ways. SenixVIEW obtains the measurements via serial data interface requests in the *continuous* or *start-on-poll* mode. The values or states of the selected output(s) are also displayed (sensors operating in SYNC modes cannot be viewed).

Sensor screen

Connect SenixVIEW to the sensor (menu: **Sensor – Connect**) as described on page 43. SenixVIEW automatically selects the **Sensor** icon ①, displays the distance in real-time with a repositioning target symbol ②, shows analog output value(s) on meters ③ and shows switch state(s) as symbols ④. Additional display icons ⑤ offer features described below.

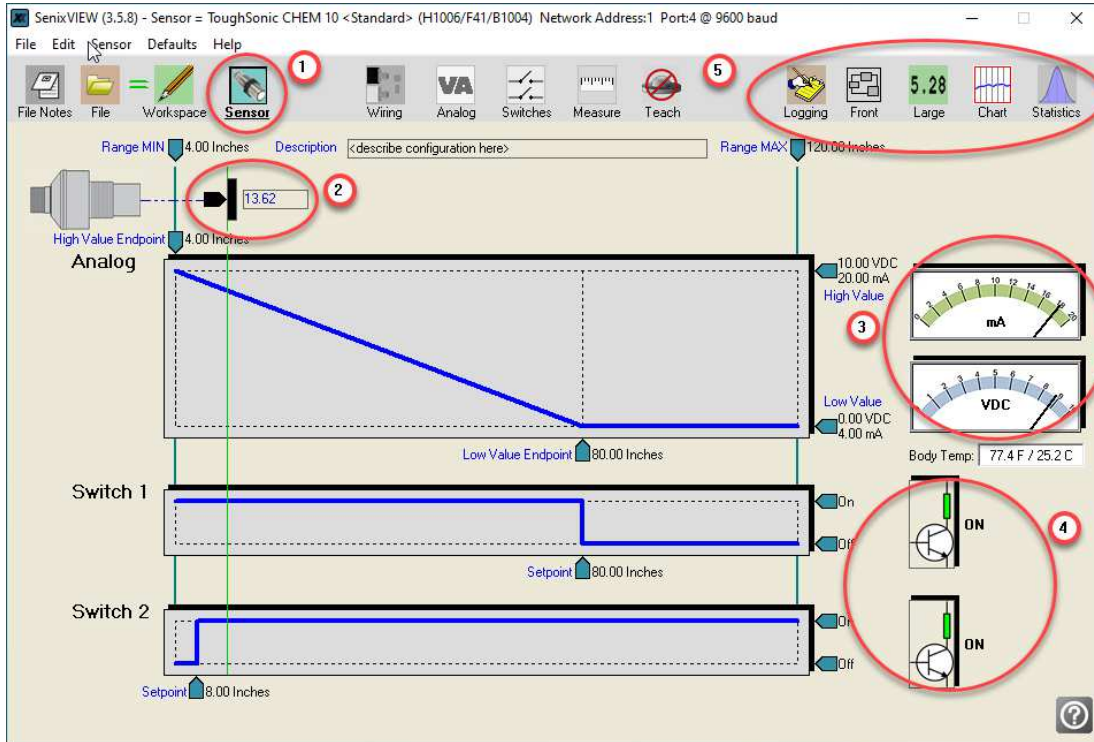
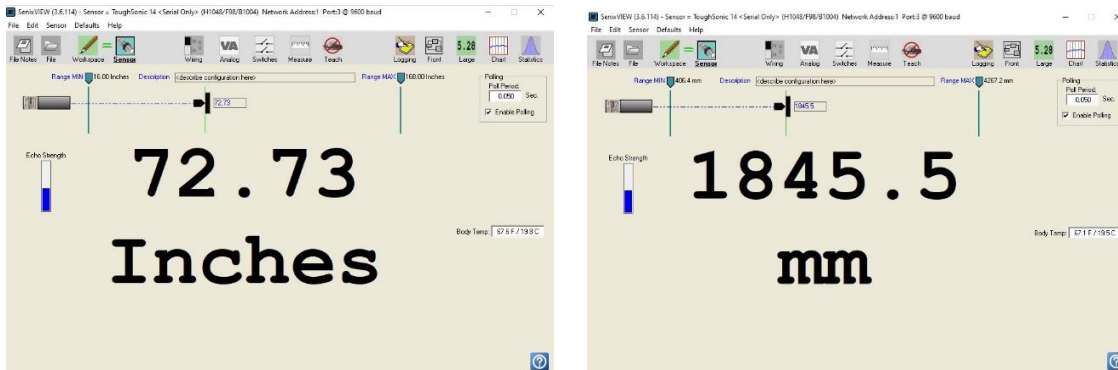

Figure 27 - SenixVIEW Distance Displays

Serial Only Models

The SenixVIEW sensor view screen will display just the digital distance value in the user's selected units.



Analysis Tools

Several tools are available in SenixVIEW which are very useful in viewing sensor performance while tuning or using SenixVIEW.

Strip Chart

Click the **Chart** icon to view data in strip chart format. Both filtered and unfiltered data are displayed. The strip chart is very handy to see target stability over shorter time windows.

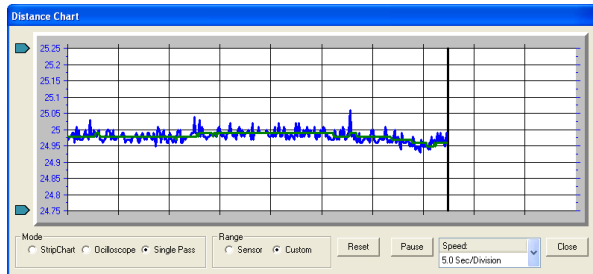

When Reference Target Temperature Compensation mode is selected and calibration has been done, the Chart tool can show the unfiltered data in blue and the filtered (or compensated) data in green. The chart tool is useful to track compensation performance as ambient temperatures rise and fall.

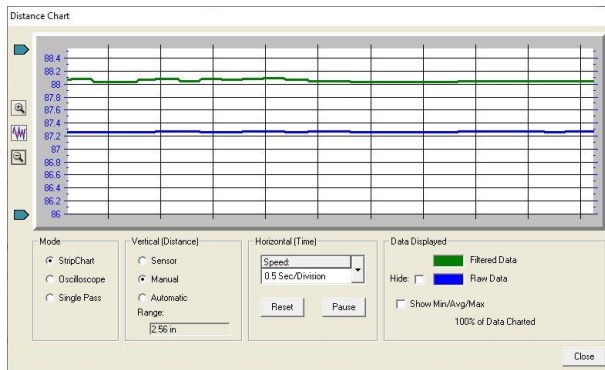

Large Display

Click the **Large** icon to pop up a large digital display that can be viewed from afar. The display can be configured to show distance, volts, current, or switch status in a large format for easy viewing. It can be positioned anywhere and enlarged or shrunk. To bring it up any time click the Front icon.

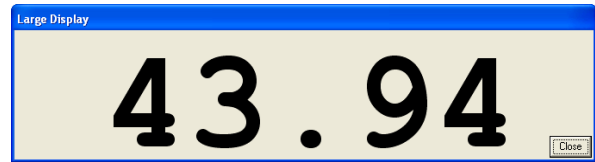

Statistics

Click the **Statistics** icon to view statistics calculations. The statistics tool is very handy to see target stability over longer time windows. Both the Strip Chart and Stability windows can be displayed at once, and even linked.

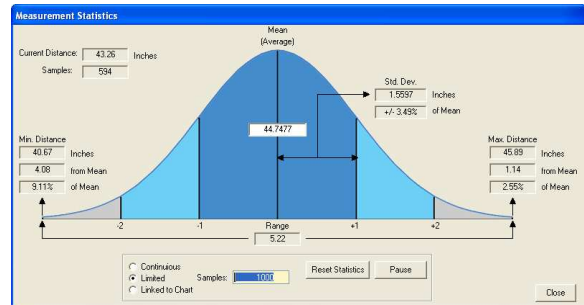

Data logging

Click the **Logging** icon to record data to disk for view or export to Excel.

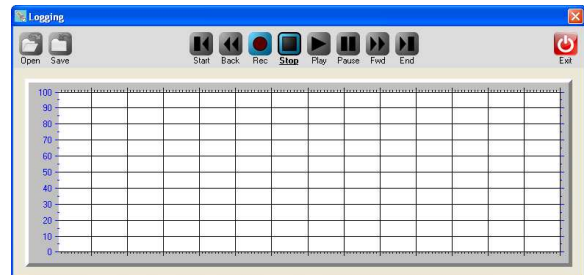

Measurement Rate

The *measurement rate* is how often the sensor measures the target distance. It does not require adjustment in most applications. Default rates are:

- TS 3, 12, 14: 20 Hz (50 ms *measurement interval*)
- TS-30: 10 Hz (100 ms interval)
- TS 50, 50RM: 5 Hz (200 ms interval)
- TS 50P: 5 Hz (200 ms interval)

To accommodate special requirements, the rate can be adjusted from .0001 to 200 meas./sec (*measurement intervals* from 2.78 hours to 5 ms) using SenixVIEW. Rate selections are also available using TEACH 24 through 28 (ToughSonic 3, 12, 14, and 30). TEACH-17 restores the default rate. **Note:**

Sensor current consumption increases significantly at the smallest measurement intervals (fastest cycling).

SYNC activation directly reduces the *measurement rate* by the number of master *SYNC phases*. For example, a ToughSonic 12 sensor (20 Hz default rate) set for 3 SYNC phases has the measurement rate reduced to 6.66/sec (20 divided by 3).

Maximum Target Distance Effects

The time required to detect a target is affected by the speed of sound in air. Sound travels at about 1 ms/ft. (3.3 ms/meter) so a target at 10 feet (3m) results in an echo delay of about 20 ms (the sound has to travel out then back). If the *measurement interval* is less than that time the target echo will go undetected, or may be detected in the next cycle, causing erratic measurements.

The maximum distance a sensor can detect a target is the shorter of (a) the sensor model's maximum range, (b) the user-adjustable RangeMAX parameter, or (c) the farthest distance a target echo can return before the next measurement begins (measurement rate limited). Setting the *measurement interval* faster than the default may restrict the maximum detectable target distance (see Table 3).

Measurements per second	Measurement Interval ms	Approximate Max Range in. (cm)
5	200	1080 (2743)
10	100	540 (1372)
20	50	288 (732)
40	25	144 (366)
100	10	54(137)
200	5	24 (61)

Table 3 - Maximum Range vs. Measure Rate

Measurement Stability Effects

If the measurement rate is set too fast the sensor may detect residual echoes from a prior measurement cycle, causing measurement instability. This is more common in liquid tanks and presents as jumpy targets or short measurements.

This effect is more prevalent at cold temperatures because sound absorption in cold air is less and it takes more time for echos to decay.

Multi-echo issues are minimized by slowing the measurement rate, reducing the sensitivity, and/or using materials to absorb or deflect the ultrasound.

Output Response Time

The default response time for all outputs is the *measurement interval*. The analog, switch and serial ASCII streaming (if enabled) outputs are updated after each measurement cycle (serial data is not available in SYNC operation).

The response time is affected by several sensor user-adjustable features using SenixVIEW:

1. The *measurement rate* (pg. 34) can be used to directly increase or decrease response time.
2. *Filters* (pg. 38) can be selected to process measurements for improved stability. Some *filters* update outputs after each *measurement interval* while others require several intervals. Filters can decrease response time.
3. *Time Delays* (pg. 41) can be used to create system responses that might otherwise require external controllers or time delay relays. They directly delay the response of the output(s) to which they are applied.
4. For SYNC master and slaves the *Sync interval* increases as a multiple of the *measurement interval* times the *number of sync phases*.

The factory default settings are all *filters* off and all *time delays* set to 0. **When testing a new application keep filters and time delays off for best visibility of measurement stability!**

Filters

Filters are processing features that reject and/or smooth measurements, and/or limit the rate of change of the sensor distance (and therefore outputs). Their purpose is to improve sensor performance in real-world applications. The factory default is all filters OFF, where the sensor outputs are set immediately in response to each measurement (not including any switch time delays).



Keep filters off during setup to understand measurement stability, then enable filters as required for the application.



All filters are turned off when the sensor is unlocked (TEACH mode)

When using filters, the first valid measurement after power ON becomes the initial condition for all further processing. The Filter Options are shown in block diagram below, followed by a description of each.

Overview

Figure 28 shows the flow of distance measurements through the filters to the outputs. Filters are applied in order of flow from left to right (input to output). None or one selection can be made from each category (Input Rejection, Averaging and Distance Limiting). As filters are enabled the output response time is generally slower. Some filter settings are not usable in applications requiring a fast response time.

SenixVIEW Filter Selection

Click the **Measure** icon on the main screen to open the Measurements dialog. The location of the Filter Options is shown below.

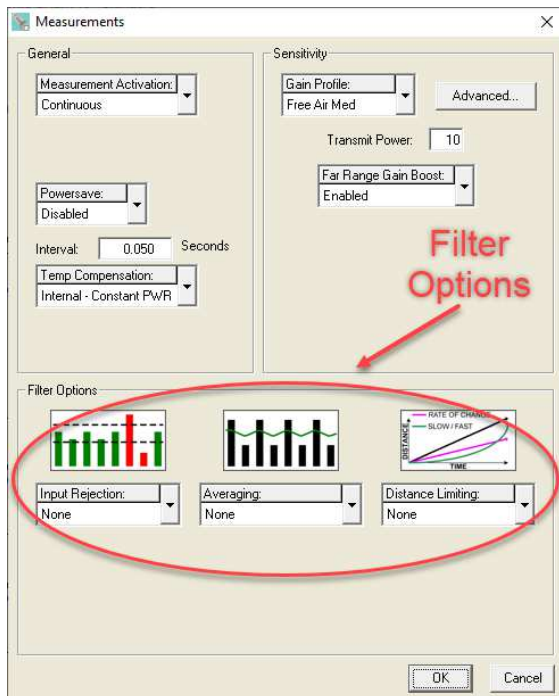

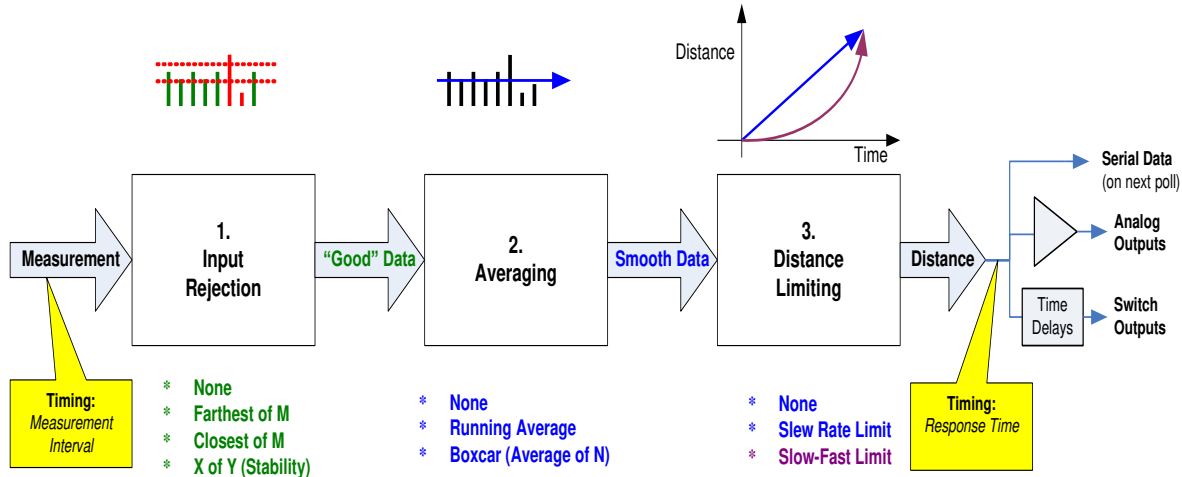

Figure 28 - Filters Block Diagram

Input Rejection Filters

As seen in figure 28, input rejection filtering precedes any averaging filtering. Input rejection filters ignore some measurements. The input to these filters is the raw sensor distance measurement. The output (“Good” data) is then input to an averaging filter (if used).

Closest of M Measurements

The sensor performs M distance measurements and rejects all except the closest. The number of samples (M) can be set to any value from 2 to 999. The *response time* is slowed by a factor of M. For example, if M=3 and the *measurement interval* is 50 ms the *response time* is 150 ms (not including any successive filters or switch time delays).

This filter is useful for applications where the desired result is the closest object detected in a given period of time. Examples include detecting the peak value of material flowing on a conveyor, or maintaining a measurement value of a poor target (weak or intermittent echo).

Farthest of M Measurements

The sensor performs M distance measurements and rejects all except the farthest. It is otherwise identical to the Closest of M filter described above.

This filter is useful to ignore an unintended or unwanted target that occasionally passes between the sensor and the intended target. Examples include ignoring mixer blades in tanks, ignoring traversing objects not the intended target, or rejecting sporadic interference (electrical, physical or acoustic).

X of Y Filter (Stability)

At least X measurements of the previous Y must be within +/- 6.25% of the latest measurement. All measurements are ignored until this condition is satisfied, i.e., the target must remain stable before the sensor will process it. If the target remains unstable a new distance measurement will never be established.



Instability is different from the “no target” condition (red target indicator). A perfectly detected target (green) may be in motion and thereby unstable.

The degree of stability required is user adjustable by changing the values of X and Y. The range of values for X is 1 to 7 and for Y is 2 to 7.

As long as each new measurement X falls within bounds the sensor response time is unaffected and the latest X is available for output (excluding averaging and switch time delays used). If the input data fall out of bounds then a delay will occur before the filter criteria can again be satisfied. The delay for a re-stabilized target could range from 1 to X measurement intervals depending on the history of the prior Y measurements.

This filter is disallowed when using Start on Poll measurement activation.

Averaging Filters

The averaging filters receive their distance data from the input rejection filters (figure 28). The averaging filter response time is therefore affected by the rejection filter selections. If an unstable target is detected by the stability filter (x of y), the averaging filter and subsequent processing are suspended at the current distance until stability returns. The distance

output of the averaging filters is rate-of-change restricted by a distance restriction filter (if used).

Boxcar Average

This filter calculates the average of N inputs (N = 2 to 255) passing through the rejection filter. The process is repeated every N inputs. The *response time* is therefore slowed by a factor of N. For example, if M=3 for a rejection filter and N=10 for the Boxcar average then the update period at a 50 ms *measurement interval* is $50 \times 3 \times 10 = 1500$ ms.

Running Average

This filter calculates the average of N inputs (N = 2 to 255) passing through the rejection filter. The average is updated after each input rather than after N inputs as for the boxcar average. The output response of this filter is therefore smoother than the boxcar filter since the output is updated more frequently.

This filter is disallowed when using Start on Poll measurement activation.

Distance Limiting Filters

The distance limiting filters clamp the rate of change of measured distance before setting sensor outputs. These filters limit the rate of change of data received from the input rejection and/or averaging filters (figure 28). The limited distance then drives the sensor outputs (not including switch time delays).

Rate of Change

A maximum rate of change of distance ($\Delta D/\text{sec}$) is limited to a maximum value, whether increasing or decreasing. The maximum value is a user-entered parameter with a range of .003 in./sec to 173 in./sec.

An example use of this filter is limiting the rate of change allowed when driving a motor or other mechanical system.

Slow-Fast

In Slow-Fast, if the target position changes quickly, the sensor assumes it is a false change but starts to recalculate slowly toward the new position. If the new position remains stable the sensor gradually increases the rate of change of measurement toward the new position until it is reached.

TEACH-6 can be used to toggle this filter on and off, and the filter can be set OFF by TEACH-17.



When turned on using TEACH-6 the filter does not operate until TEACH mode is ended!

This filter is disallowed when using Start on Poll measurement activation.

This filter is used for targets that change position slowly but have occasional interruptions. Examples:

- Measuring a roll diameter - holds a stable roll measurement yet readjusts the measurement in a reasonable time during changeovers
- Mixer tanks - Ignores rotating mixer blades that pass occasionally between the sensor and liquid.
- Ignore unintended targets passing between the sensor and the intended target, such as a traversing mechanism on a printer ink well.

Output Response Time

The output update rate is a function of the *measurement interval*, filter selections and parameters, and switch time delays (page 41).

Filter (2)	Update Interval Multiplier (of measurement interval)
Closest of M Farthest of M	M
X of Y (1)	1 (stable target) 0 (unstable target)
Boxcar Average	N
Running Average	1
Rate of Change Slow-Fast	1
(1) Once detected, regaining a target will be delayed by 1 to Y measurement intervals. (2) During setup, turn off filters for best visibility of real-time measurements.	

Table 4 - Filter Response Time

Assuming measurement interval **I** with a default of 50 ms, here are some example response times:

- **No filters**
Response time = I (50 ms)
- **Closest or Farthest of 20 measurements**
Response time = I * M = .05 * 20 = 1 sec
- **Boxcar Average of 10 measurements**
Response time = I * N = .05 * 10 = 500 ms
- **Running Average**
Response time = I * 1 = 50 ms
- **Closest of 20 and Boxcar average of 10**
Response time = I * M * N = .05 * 20 * 10
Response time = 10 seconds

Time Delays

Time Delays are used to cause actions that might otherwise require external controllers or time delay relays. They delay the response of the output(s) to which they are applied and are useful for control and alarm functions. All time delays are adjustable between 0 ms to 5.46 minutes at a 5 ms resolution.

Switch Time Delays

Each switch has 3 independently adjustable delays:

- On Delay
- Off Delay
- No-Target Delay

A time delay begins when the condition that triggers it first occurs (a distance measurement that could turn a switch ON or OFF, or no target). Time delays are re-triggered, i.e., the trigger condition must remain active for the full time delay period or the time delay will be reset to zero. If the trigger condition remains for the full time delay period then the corresponding action takes place (switch turns on or off).

Switch time delay setup is shown on page 26.

Examples uses include:

- Set an alarm if the sensor loses the target for an excessive time period, or material stops flowing on a conveyor (jam condition)
- Force a switch state for a minimum time to assure correct operation of other equipment

Analog “No Target” Time Delay

Analog outputs can be set to their high value, low value or not change if no target is detected. The current loop and voltage have independent selections.

A time delay begins when the no target condition first occurs. The time delay can be re-triggered, i.e., no target must exist for the full time delay period or the time delay will be reset to zero. If the no target condition remains for the full time delay period then the analog outputs are set to their no-target values.

Analog time delay setup is shown on page 22.

Example uses include:

- Force a system shutdown on loss of a target
- Controller detection of no target by setting the output value outside the normal range

No SYNC Time Delay

Under SYNC Slave activation (pg. 31) the slave sensor measurement is triggered by a master input. If

that input is missing for a period exceeding the *No SYNC Time Delay* the switches and analogs are set to their “No SYNC” states and values respectively.

Temperature Compensation

At room temperatures, a change of 10 degrees Fahrenheit will result in approximately 1% change in the speed of sound and therefore the measured distance. Senix sensors have two types of temperature compensation available, internal and external. Either can be used to reduce the impact of ambient temperature changes. They can be enabled under the SenixVIEW >Measure > Temperature Compensation selector, or by using TEACH 32/33. The default is DISABLED.

Temperature compensation is less important if the temperature environment in which the sensor is used remains constant.

Internal Temperature Compensation

ToughSonic® sensors have an internal temperature sensor used in temperature compensation. The sensor will not compensate for rapid temperature changes or for temperature variations between the sensor and target. Best performance is obtained when the sensor body tracks the surrounding air temperature.



The sensor should be protected from the sun or other forms of radiant or conducted heating when using the internal temp compensation method.

Choose Internal – Constant PWR if the sensor remains powered. Several degrees of self-heating are allowed for in this compensation mode. A warm-up period of approximately 30 minutes should be allowed when using Internal – Constant PWR mode.

Choose Internal – Periodic PWR if the sensor is only powered to take a measurement. Temperature compensation will be done without allowance for self-heating.

External Temperature Compensation Using RTTC

Reference Target Temperature Compensation (RTTC) is available in SenixVIEW version 3.6.200 and higher. Your sensor firmware must be version v47 or higher which can be installed from SenixVIEW 3.6.200 or higher at menu item *Sensor*

ToughSonic® Family Sensors – Installation & Operating Instructions

>Update Sensor Firmware... before you can use RTTC.

RTTC is a temperature compensation method that uses a fixed reference target in the measurement beam to allow the sensor to correct for temperature in the measurement path. RTTC takes two measurements each cycle. One is of the reference target near the sensor and the other is the user target at some distance. This method is best for removing diurnal temperature effects that cause measurement drift in applications where more critical measurements are required. It requires a reference target coupled to the sensor. The user can install an accessory reference target from Senix or utilize a target that is added to the sensor mount. This method can track rapid changes in temperature and is not affected by sun or artificial heating sources acting on the sensor. A calibration must be done when enabling RTTC. Calibration can be done at any time or temperature. A separate document on RTTC is available at the Senix.com website in Support.

Reference Target Calibration

Once the reference target position has been calibrated in sensor memory, any deviation in its position later is attributed to a temperature effect on the speed of sound. The correction applied to the reference target distance is proportionately applied to the user target distance, thereby correcting for temperature effects over that greater distance.

A reference target is a small surface or rod in the sensor's sound cone at a standard distance of about 7", 14", or 21" from the sensor face depending on model (7" for the 3, 12, 14, and L100; 14" for the 30 and L300, 21" for the 50 and L500). Accessory reference targets are available from Senix. A custom target can be installed at a non-standard distance. It must be carefully placed in the sound detection area, be a flat surface or curved, and if a rod it should be perpendicular to the sensor axis. See the RTTC article at senix.com/support.

There are two basic steps to calibration. In the first step, before enabling Reference Target, the far (user) target is acquired and its echo stabilized. The second is calibration using the RTTC calibration routine found in SenixVIEW.

Step 1: Optimize the User Target echo

The sensor should be mounted in a secure way for calibration. A tape measurement must be made of the true distance from sensor to the user target. The

sensor must be perpendicular to the target surface. The sensor or the user target should not move during the calibration process. Choose a user target at a distance of at least 1/4 the sensor's maximum working distance and greater if possible. **If the user target is not detected correctly due to the reference target, increase the Range MIN term to blank the reference target.** A value greater than the reference target's distance is required to blank that echo and it must be uploaded to the sensor.

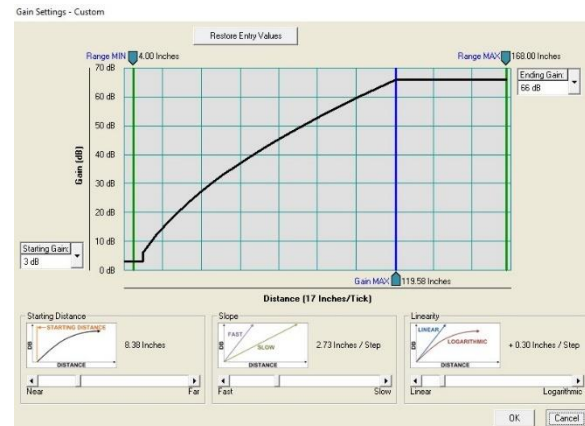

Open the advanced window found by clicking *Workspace > Measure > Advanced...* A graphic of sensor sensitivity over time (distance) is displayed. Below are three slide adjustments, Starting Distance, Slope and Linearity. Move the slope slider until MAX Gain occurs at the sensor's Optimal distance found in the Specifications section of this manual. Click *OK >OK* and *Upload Workspace to Sensor*. The intended user target should now be seen in the Sensor view. If the value is not correct it will be corrected in the next step.

Step 2: Calibration

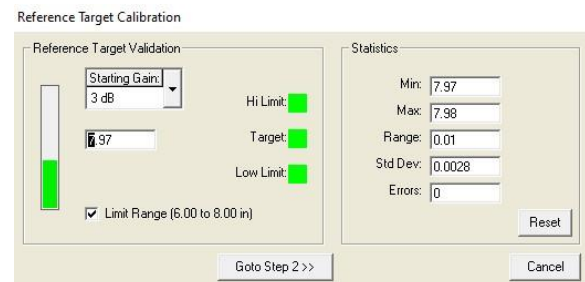

Start in Sensor view. Navigate to menu item *Sensor >Reference Target Calibration....* The first window is Cal step one for Reference Target Validation. The MIN Range and MAX Range parameters are automatically adjusted to allow the standard

reference target to be captured. If it is not captured, uncheck the Limit Range box for non-standard user-supplied reference target use. The echo strength graph should be green. If red, increase the Starting Gain to 6 or 9dB and click the Reset button. When there is a green echo strength seen, low standard deviation and no errors, click *Goto Cal step two*.

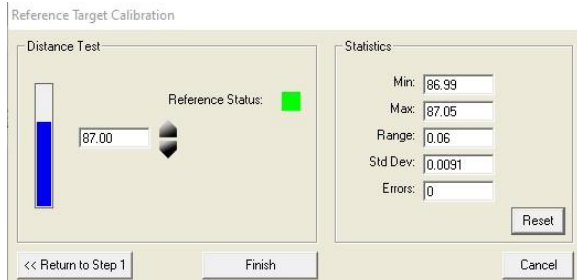

In Cal step two the user target distance is shown. If the value is approximately correct continue by clicking the up or down arrows to bring the distance to the known value taken by tape measurement. Use the Reset button to assist in settling the distance value. When it agrees with the known distance and is stable with no errors, click *FINISH*.

If Cal step two is unsuccessful because the proper user target is not showing, click *CANCEL* and return to the *Measure >Advanced...* window and move the Slope slider left if no target was found or farther to the right if the target was the wrong one. Hit *OK > OK* and *Upload Workspace to Sensor*. Restart Step 1.

SenixVIEW Software

SenixVIEW software allows you to select and calibrate sensor outputs; modify sensor features (parameters); view, analyze and/or log measurements for performance evaluation; and save Setups to disk for later recall and application cloning.

Install SenixVIEW

SenixVIEW runs on a Windows PC and connects to a ToughSonic sensor via a serial data COM port or, with suitable adapter, via a USB port.



When finished, Reference Target mode will display two boxes in Sensor view beside the distance display box. The R box is green if the reference target is being detected; red if it is not. The U box is green if the more distant user target is detected; red if it is not. If the Reference box goes red the sensor will continue to use the last known position of the reference target in its calculations. Correct the missing target and repeat the calibration above. If there are any adjustments to sensor speed, power, or sensitivity a new calibration should be done. If the sensor is changed or the reference target removed and replaced redo the calibration. If the wrong User target is occasionally detected, increase the Range MIN term for foreground interference, or lengthen the SLOPE distance if in the far region.

A significant improvement in measurement stability and accuracy is possible with Reference Target Temperature Compensation. Temperature changes, sunshine on the sensor, heating of tank interiors etc. do not affect the sensor measurement as they could with the internal compensation modes. Sensor installation requires the extra length associated with the reference target and allowance for this change in sensor height must be made.

Get SenixVIEW at <https://www.senix.com/technical-support/documentation/#>

Application Setups

A *setup* is a particular combination of sensor parameters that you establish for an application. Setups can be created or changed in the SenixVIEW workspace, or moved in/out of the workspace from/to the sensor or file as shown below:



- **Main SenixVIEW Screen**

You have two screens available: Workspace view and Sensor view. Setup parameters are viewed and changed on the Workspace screen

ToughSonic® Family Sensors – Installation & Operating Instructions

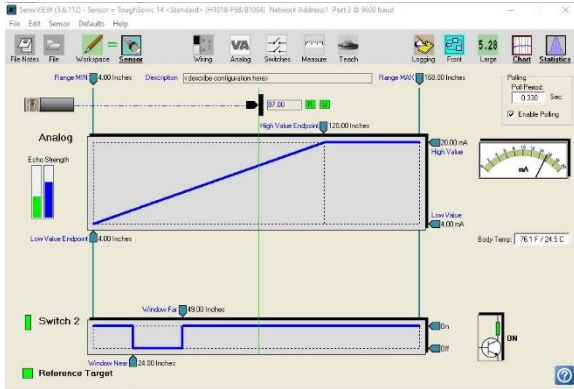

or in pop-up dialogs by clicking one of these icons:



Sensor view contains current measurement, switch status and analog level.

• Main Screen View

The main screen displays a *setup* of (a) an attached sensor, (b) a file stored on the computer disk, or (c) the workspace, as selected by these icons:



In this example the **Workspace** is displaying on the main screen (icon is outlined, with **bold underlined** title), and the workspace matches the file but not the attached sensor. Click the EQUAL sign to see a printable list of all sensor parameters. Click the NOT EQUAL sign to see which parameters aren't equal between views.

If the File icon is grayed out, clicking it will open a dialog to select a file from the computer disk. If the Sensor icon is grayed out, clicking it will open a Sensor Connect dialog to connect a sensor.

Moving a Setup

Setups can be moved between the Workspace and a disk file, or between the Workspace and a sensor. Movement is accomplished in three ways:

1. **Using Icons** - use the mouse to either (a) right-drag or (b) shift-left-drag the **Workspace** icon to either the **File** or **Sensor** icon, or vice versa. All movement must be in or out of the workspace.

For example, to move the workspace to the sensor drag the Workspace icon as shown below:



2. **Using Menu selections:**

File > Read File to Workspace

File > Write Workspace to File

Sensor > Move Sensor to Workspace

Sensor > Move Workspace to Sensor

3. **When connecting a Sensor** – When using menu **Sensor > Connect** (page 45) SenixVIEW asks if you want the setup copied to the workspace. Click **Yes** to copy it.

Creating a Setup

Setups are created or modified in the workspace. There are 3 ways to create a new Setup:

1. **Start with a Factory Default** – Click **Workspace** > **Default Settings**. Select the model of the sensor you intend to use with the new setup. When a sensor is connected, only the correct factory default can be selected.
2. **Start with a Sensor** – Move a setup from a connected sensor into the workspace.
3. **Start with a File** – Move a previously stored disk file into the workspace.

After loading, the workspace the parameters can be modified, then moved to a file or uploaded to a sensor. **If the setup is not uploaded or saved it is lost when exiting SenixVIEW.**

Saving a Setup

Make the workspace changes you want to test, saving them to the sensor as often as needed until the sensor is operating as needed. When finished, save the workspace to a disk file for future reference or cloning (see Moving a Setup). Use a meaningful filename when saving. You are given opportunity to enter notes during the save operation. Notes are saved with the file and NOT loaded into the sensor with the setup later.

Connect a Sensor

SenixVIEW requires both a physical and logical sensor-to-PC connection. Physical options include a USB-to-COM adapter (see Senix offerings on page 15).



ToughSonic serial RS-485 models require a RS-485 interface converter

1. Install a serial adapter between the sensor and USB port on the PC. Use the adapter included with a Senix software kit (page 9) or wire it yourself (page 26). Connect the sensor wires by color to the adapter's terminals. Do not let unconnected wires touch anything.
2. Apply sensor power: The rear target indicator should be lit (page 16).
3. Logical Connection: Connect SenixVIEW to the sensor using menu selections **Sensor > Connect**.

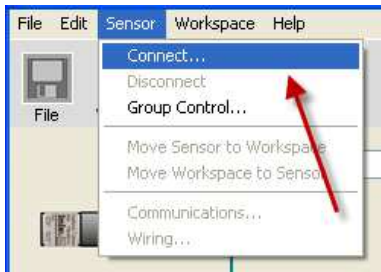

4. The Connect Sensor dialog then appears. Choose the COM port, Baudrate, and Network Address and click Connect. If the COM port is unknown, unplug your USB cable and click COM Port Survey and note the reported ports. Plug in the USB cable again and repeat the survey. The COM port that appears is the correct one. A default sensor has 9600 Baudrate and Network Address 1. Click Connect:

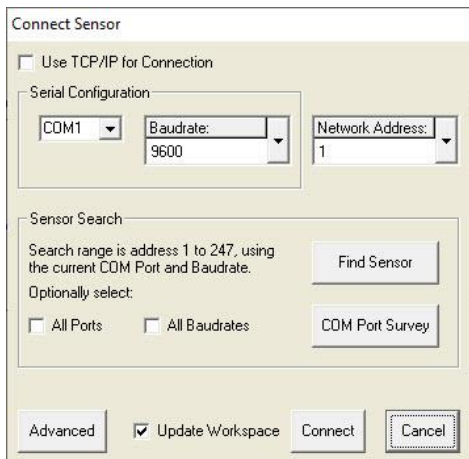

When the connection is made a copy of sensor parameters will be uploaded to SenixVIEW Workspace if the Update Workspace box is checked. If you intend to clone a sensor with the current Workspace, uncheck the box.

5. If the following message appears



check the (a) wiring, (b) power and (c) interface selections. Check **All Ports** or **All Baudrates** and use **Find Sensor** to scan all sensor addresses. SenixVIEW will identify the first sensor found.

6. When a sensor is found this message appears:



Click OK and the Connect Sensor dialog is redrawn with the correct parameters (step 4).

- If the sensor isn't found, check that the serial to USB converter matches the sensor serial type found on the label.

Outputs & Indicators

ToughSonic 3, 12, and 14 sensors are factory configured with the voltage and current loop outputs selected. Other selections are possible.



After connecting a sensor, click this icon to select or reconfigure the outputs and indicators.

For ToughSonic 3, 12, and 14 sensors the following 6-wire dialog appears. The factory default outputs are 4-20 mA current loop (black wire) and 0-10 VDC (White wire), and the square indicator displays analog status and the rectangular serial data TX.

ToughSonic® Family Sensors – Installation & Operating Instructions

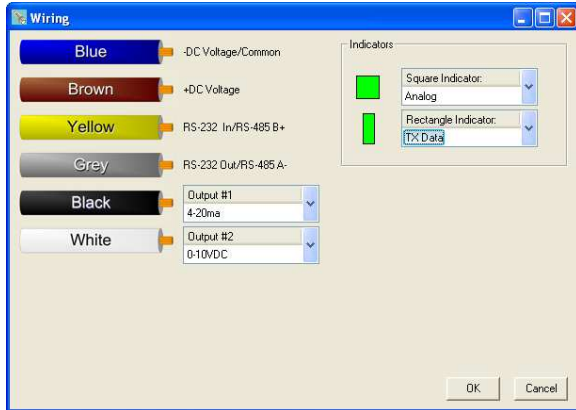

For ToughSonic 30, 50, and 50P sensors the following 9-wire dialog appears. Note that each output has a separate wire in these models.

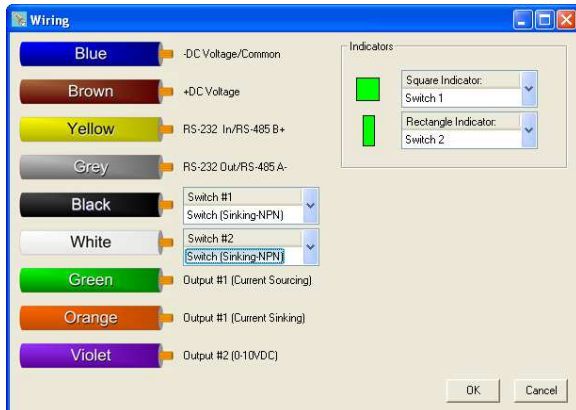

Select the outputs before connecting your equipment. Do not change outputs when connected to operating equipment!

Output Indicator Selection

Choose which function will be shown by each output indicator found on the rear of ToughSonic 3, 12, 14, and 30 sensors (except serial-only models). Reference Target can only be selected once Reference Target mode is enabled in the Measure window. Switch choices are only accepted when the output has been designated a switch output in the Wiring window. The choices for the Square and the Rectangular indicator are the same, however the Square indicator can only indicate Switch #1 while the Rectangular indicator can only indicate Switch #2.

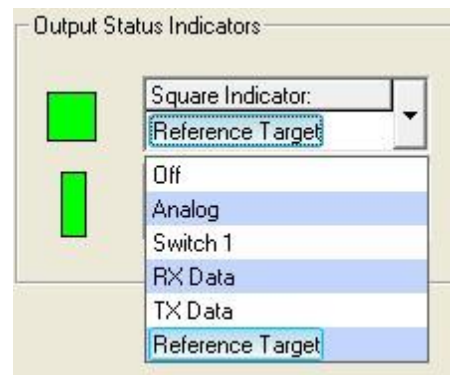

If Indicator or wiring changes are made on either of these dialogs and the OK button clicked, the changes are made and the sensor automatically disconnects from SenixVIEW: Reconnect SenixVIEW to the sensor (page 45) to resume SenixVIEW with the new outputs.

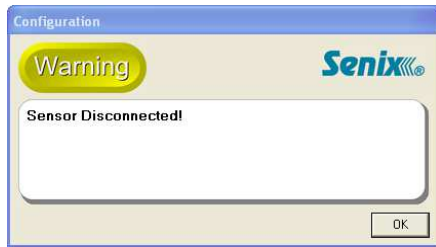

Analog Dialog



To modify analog output features not available on the Main Screen, click this icon to display the Analog dialog.

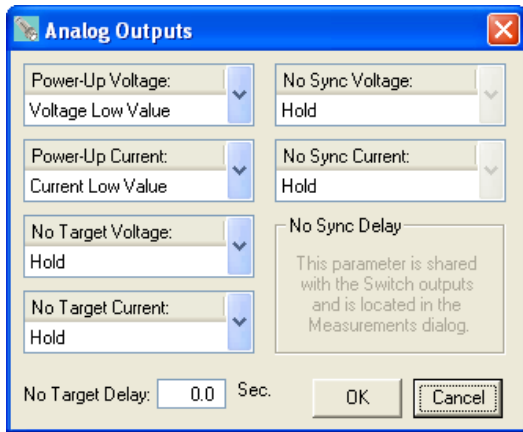

Switch Dialog

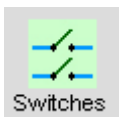

To modify switch output features not available on the Main Screen, click this icon to display the Switch dialog.

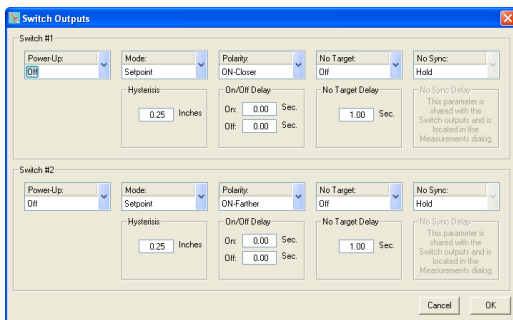

Measurements Dialog



To modify measurement parameters not available on the Main Screen, click this icon to display the Measurements dialog.

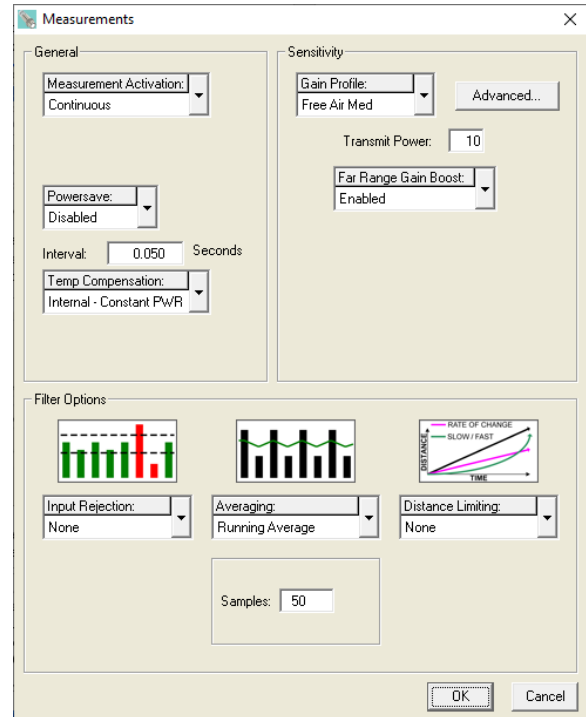

This dialog is used to change activation (Continuous, SYNCH, or Start on Poll), the rate of measurement, temperature compensation mode, sensitivity, and to apply filters.

Temperature Compensation is available for several operating modes. Reference Target mode requires a reference target attached to the sensor. Custom heat allowance is available when using the internal temperature compensation sensor and under constant power mode.

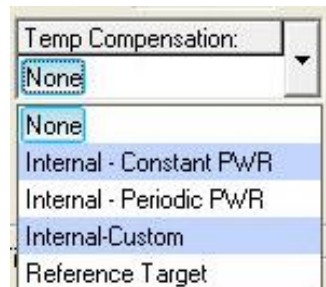

Activation Modes

The sensor can run continuously or only when polled for data as an application requires. It can be run in the SYNCH mode to measure either in phase or out of phase with other nearby networked sensors or to solve an interference issue.

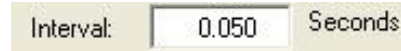

The measurement rate is adjustable by changing the interval between measurements. A sensor will run at that rate continuously, or if filters are being used, will accumulate samples at the interval spacing.

For additional information see the Filters and Temperature Compensation sections in this manual.

TEACH Enable / Disable



The TEACH feature is available on ToughSonic 3, 12, and 14 series. Once connected to SenixVIEW, the TEACH

button will be displayed for these models.

The button can be disabled for security so that changes cannot be made at the sensor.

To disable the sensor's TEACH button, click this icon. The left version of the icon shows TEACH enabled and the right version disabled. Teach adjustment is described on page 50. ***The button is disabled only after the configuration is moved to the sensor!***

For information on using the TEACH functions see the TEACH-ADJUST section later in this manual.

Echo Strength Indicators

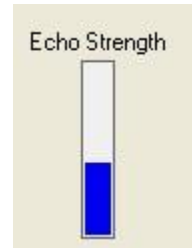

The screen includes an Echo Strength indicator. It will be BLUE when the echo strength is sufficient. If echo strength drops low, it turns RED. Improving the target size and orientation, or an adjustment of sensor parameters such as power or sensitivity settings can improve echo strength.

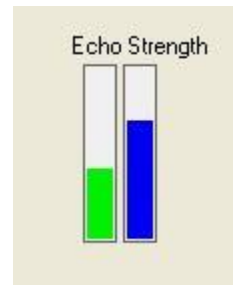

When Reference Target Temperature Compensation mode is used, an additional echo strength indicator is displayed for the Reference Target in GREEN. If the Reference Target echo strength is low that bar turns RED and should be corrected by running a new calibration.

Sensor Adjustment

Sensor setups are made in the Workspace then uploaded to the sensor. The screen image below shows the screen with the **Workspace** icon selected.

- 1) Setups can be moved between the Workspace and a disk file or sensor (see page 43).



Setup changes do not take effect until uploaded to the sensor! *Remember to save setups to disk for future recall.*

- 2) Click one of these ICONS for extended features associated with the analog outputs, switch outputs, measurements or TEACH button.

Analog adjustments: see page 22

Switch adjustments: see page 26

Measurement adjustments: see page 47

Teach Security: see page 48

- 3) Enter up to 32 characters to describe a setup. This reminder text is stored in the sensor or disk file when the parameters are moved or saved.
- 4) Click the distance text to edit the *Operating Range* (see page 34). Range MIN is the left parameter and Range MAX the right, e.g., clicking the 4.00 inch (left) value yields:

Range MIN:

Enter a new value then press <Enter>.

- 5) Click the distance text of high and/or low analog endpoints to calibrate the analog outputs. The voltage and current outputs share the endpoints. Right-click either value to **reverse the slope**.
- 6) Click text of the high and/or low values to change the output range. The voltage and current loop outputs are independently adjustable.
- 7) Click the distance text of the switch setpoints to calibrate the switch ON distances. Hysteresis and window options are found by clicking the Switches icon (page 26). Right-click the value to **toggle the switch state**.
- 8) These icons are grayed out in **Workspace** but operate when connected to a sensor (click **Sensor** icon). See Sensor Viewing on page 35.
- 9) Equality symbols indicate whether the Workspace is equal or not to the File and Sensor. Click on an unequal sign to reveal a printable list of differences. Click an equal sign to get a printable list of all parameters.

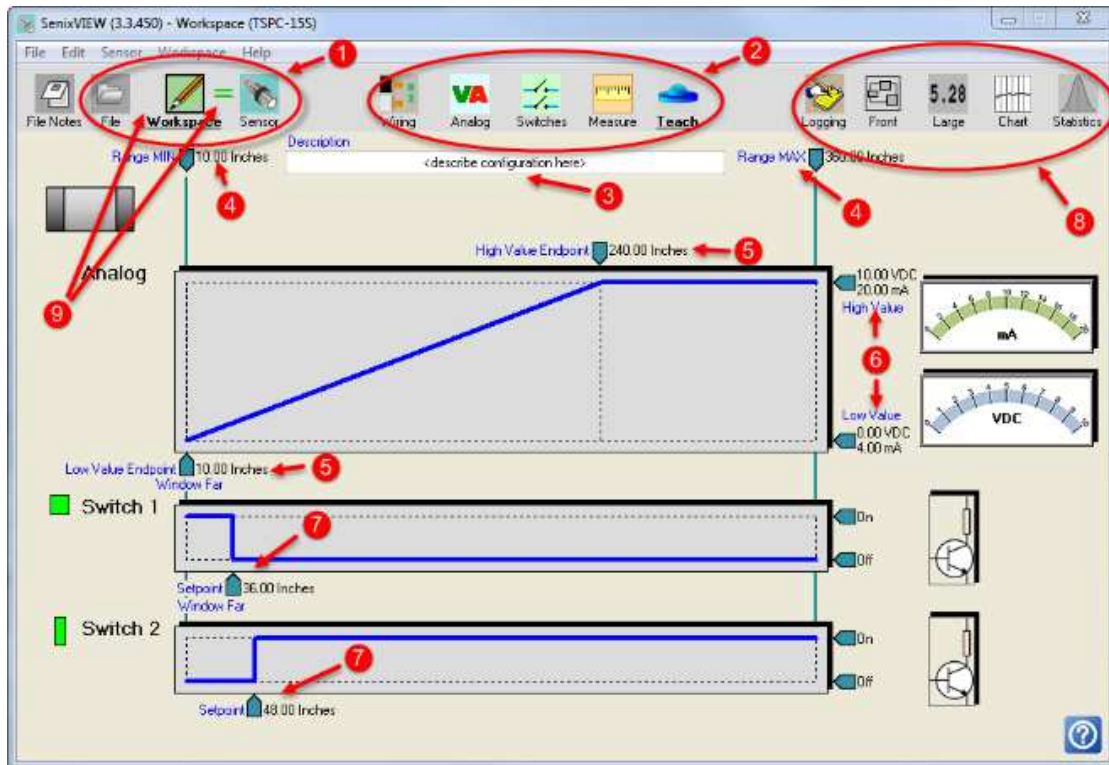

Senix Corporation, 10516 Route 116 Suite 300, Hinesburg, VT 05461 USA

Web: www.senix.com, e-mail: Technical.Support@senix.com

Teach Adjust

On the ToughSonic 3, 12, 14, and 30 series models many sensor features can be adjusted using the rear **TEACH button** and **Target Status Indicator**. These are called “teachable” because, for some features, the sensor stores actual target measurements as calibration distances for analog endpoints and switch setpoints. All changes are stored in non-volatile memory and retained when power is off. A list of Teach features is included in Table 5. Document references such as “TEACH-3” correspond to the features listed in that table.

TEACH usage is not required. All adjustments can be done in SenixVIEW, where additional features are available that cannot be set with TEACH.



For security, the Teach button can be disabled using SenixVIEW. Teach 12-15 remain enabled in a SYNC sensor.



When setting analog or switch distances keep the target farther than the greater of the *deadband* or *RangeMIN* or invalid settings will occur.

Unlock, Lock and ALT-Teach

Locking prevents using Teach to change sensor features. The sensor is initially “locked” and must be unlocked using TEACH-3 before other Teach adjustments can be made. When unlocked the *target status* indicator color indicates target status but slowly flashes on and off (pg. 17). An unlocked sensor will re-lock:

- When TEACH-3 is used again (manual re-lock)
- 15 minutes after last use of the **TEACH button**.
- When input power is cycled off and on

Additional features are available using ALT-Teach. ALT-Teach is entered using TEACH-3 followed by TEACH-2 (see Table 5). ALT-Teach status is indicated by a double flashing indicator.

Analog Output Adjustments

The voltage and current outputs operate over adjustable distances (span) defined by setting the *endpoints*. The voltage and/or current loop outputs vary linearly with the target distance between the endpoints. Endpoints can be set anywhere between the *rangeMIN* and *rangeMAX* using Teach-4 and 5. The analog low value (0VDC, 4 mA or SenixVIEW low values) *endpoint* is adjusted using TEACH-4 and the high value (10VDC, 20 mA or SenixVIEW high

values) *endpoint* using TEACH-5. The endpoints can be adjusted in any sequence. The endpoint distances can be in any order, allowing increasing or decreasing analog slope. Adjustment is made easy by pointing the sensor at the actual target then using the **TEACH button** to memorize each endpoint. Settings take effect only if the target indicator is green. Endpoints are common to both the voltage and current outputs.

The default range for the voltage output is 0-10 VDC but can be changed to 0-5 VDC using TEACH-30.

The no-target response can be set using Teach-35-37.

Switch Output Adjustments

Switch outputs turn ON at their *setpoint* distances, set using TEACH-7 for a *switch* on Output #1 (BLACK wire) and TEACH-9 for a *switch* on Output #2 (WHITE wire). The OFF distances are set using ALT-TEACH-7 and ALT-TEACH-9 respectively, or are the factory default of 0.25 in. (6.35 mm). Both switches turn OFF if no target is detected for 1 second (disable this feature using TEACH-20).

The polarity of each *switch* can be changed between *ON Closer* than the setpoint or *On Farther* than the setpoint using TEACH-8 for Output #1 and TEACH-10 for Output #2. **NOTE: This reverses the direction of the OFF distance from the Setpoint!**

Factory Configuration

TEACH-17 will restore factory default operation and the default values described in Table 5. **The output selections, communications parameters and number of SYNC phases are not affected.**

Other TEACH Features

These and more can also be set in SenixVIEW:

Measurement rates are set using Teach-24 to 28. More options are available using SenixVIEW.

SYNC and Continuous Activation modes are set using Teach 12-14 are used to select SYNC modes, and Teach-15 to revert back to continuous operation. Activation modes are described on page 31.

Temperature compensation is OFF by default. It can be turned ON using TEACH-32 or OFF using TEACH-33. See page 41.

ToughSonic® Family Sensors – Installation & Operating Instructions

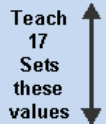
TEACH COUNT (Note 4)	TEACH Feature Description (ToughSonic 3, 12, 14, and 30 models)	Factory Defaults Set by TEACH 17			Note
		ToughSonic 12 & 14	ToughSonic 3	ToughSonic 30	
3	<p>TEACH: Unlock (or re-lock) sensor's TEACH capability. Sensor automatically locks 15 minutes after last use of the <i>TEACH</i> button or is power cycled.</p> <p>ALT-TEACH: First unlock with TEACH-3, then hold button for 2 more flashes to enter (2 again to exit). See ALT-TEACH features listed at bottom of this table.</p>				1
4	Use present measured target distance as the 0 VDC/4 mA/or custom lo <i>endpoint</i>	4 in. 10 cm	1.75 in. 4.4 cm	10 in. 25.4 cm	2,3,5
5	Use present measured target distance as the 10 VDC/20 mA/or custom hi <i>endpoint</i>	120 in. 427 cm	24 in. 61 cm	240 in. 610 cm	2,3,5
6	Toggle Slow-Fast filter (pg. 40) ON and OFF (exit TEACH to enable filter!)	OFF			2,5
7	Use present measured target distance as the switch #1 setpoint	12 in. 30.5 cm	12 in. 30.5 cm	36 in. 91 cm	2,3,5
8	Reverse (toggle) switch #1 polarity (ON closer than setpoint/ ON farther)	ON Closer			2,8
9	Use present measured target distance as the switch #2 setpoint	24 in. 61 cm	18 in. 46 cm	48 in. 122 cm	2,3,5
10	Reverse (toggle) switch #2 polarity (ON closer than setpoint/ ON farther)	ON Farther			2,8
12	Set Activation to SYNC MASTER (see pages 32 and 33)				6,7
13	Set Activation to SYNC SLAVE phase 1 (see page 32 and 33)				7
14	Set Activation to SYNC SLAVE phase 2 (see page 32 and 33)				7
15	Set Activation to CONTINUOUS (exit SYNC Master or Slave activation)	Factory Default = Continuous (SYNC off)			2,7
17	<p>Set FACTORY DEFAULT CONFIGURATION: Restores all parameters to the Factory Setting shown in the List of Adjustable Parameters, Appendix B, including those shown in columns 3-6 of this table.</p> <p>The following are NOT affected: Interface selections (black & white wires), communications (network address and baud rate), Master SYNC number of phases</p>	Teach 17 Sets these values 			
20	Switch NO TARGET delay = ON (delay = 1 second)	Factory Default = 1 second delay			2
21	Switch NO TARGET delay = OFF (delay = 0)				
24	Set measurement rate to default (see page 34)	20 per second		10 per sec	2
25	Set measurement rate to 2x default (see page 34)				
26	Set measurement rate to 5x default (see page 34)				
27	Set measurement rate to 10x default (see page 34)				

Senix Corporation, 10516 Route 116 Suite 300, Hinesburg, VT 05461 USA

Web: www.senix.com, e-mail: Technical.Support@senix.com

ToughSonic® Family Sensors – Installation & Operating Instructions

TEACH COUNT (Note 4)	TEACH Feature Description (ToughSonic 3, 12, 14, and 30 models)	Factory Defaults Set by TEACH 17			Note
		ToughSonic 12 & 14	ToughSonic 3	ToughSonic 30	
28	Set <i>measurement rate</i> to 1/Sec (see page 34)				
30	Set voltage output range to 0-5 VDC				
31	Set voltage output range to 0-10 VDC	Factory Default = 0-10 VDC			2
32	Temperature compensation ENABLED (last mode configured, or else Constant PWR mode)				
33	Temperature compensation DISABLED	Factory Default = DISABLED			2
35	Analog NO TARGET response = HOLD (no change)	Factory Default = HOLD			2
36	Analog NO TARGET response = LOW OUTPUT (4 mA, 0 VDC or custom low)				
37	Analog NO TARGET response = HI OUTPUT (20 mA or 5/10 VDC, or custom hi)				
ALT-TEACH (see TEACH-3 at top of table)					
7	Use present measured target distance as the switch #1 OFF distance.	12.25 in. 31.1 cm	12.25 in. 31.1 cm	36.25 in. 92.1 cm	2,3,5,8
9	Use present measured target distance as the switch #2 OFF distance.	23.75 in. 60.3 cm	17.75 in. 45.1 cm	47.75 in. 121.3 cm	2,3,5,8
	<p>Notes:</p> <ol style="list-style-type: none"> The sensor must first be UNLOCKED (3 blinks) before making any of the Teach adjustments shown in this table. The <i>target indicator</i> will indicate the unlocked condition as shown in on page 17. When a Factory Default configuration is set using TEACH-17 this feature is set to this value. The sensor must be detecting the intended target in range (GREEN <i>Target Status Indicator</i>) while setting this feature. When the <i>TEACH button</i> is held pressed the <i>Target Status Indicator</i> will blink RED. The TEACH COUNT column shows the number of times the indicator must blink to set the listed TEACH feature. Release the <i>TEACH button</i> after the indicated number of blinks. If the <i>TEACH button</i> is released mid-blink, that partial blink is included in the count. In the TEACH mode all enabled sensor filters are disabled to allow the sensor outputs to quickly reflect the actual target distances during the calibration process. The factory default Master Number of Phases is 2. If the number of phases is adjusted using SenixVIEW it is unaffected by any TEACH feature, including Teach 17. If the Teach button is disabled using SenixVIEW, Teach features 12 through 15 remain enabled in sensors set as a SYNC Master or Slave to permit mode changes without SenixVIEW. An RS-232 sensor placed in SYNC mode will no longer connect to SenixVIEW via RS-232 until reverted to normal operation using TEACH-15. When reversing a switch polarity using Teach-8 or Teach-10, the OFF distance of that switch (set by ALT-Teach-7 or 9) is reversed in direction about the setpoint by the “hysteresis” distance (the difference between the ON and OFF distances). The Teach reversal is not executed if the OFF distance would be out of sensors <i>Operating Range</i>. 				

Table 5 - Pushbutton TEACH Features List

Appendix A – List of Adjustable Features

These parameters can be changed using Senix SenixVIEW™. Those that can also be set using TEACH are indicated with a ► in the Teach? column. Parameters are permanently stored in the sensor memory. Features marked with ♣ in the Factory Settings column are NOT reset by TEACH 17. ♦ = implied parameters (not directly settable)

Feature	Teach?	Description	As Shipped from Factory
General Parameters			
These parameters are available on the SenixVIEW Main Screen.			
<i>Description</i>		A 32-character text field to describe the application setup. This serves as a reminder when a setup is retrieved from a sensor or disk file. It is only for reference and does not affect sensor operation.	This text: <describe configuration here>
<i>Range Min</i>		The shortest distance the sensor will provide target measurements. Closer targets may have multiple reflections resulting in an incorrect measurement at a multiple of the actual distance.	See page 8
<i>Range Max</i>		The farthest distance the sensor will provide target measurements.	See page 8
<i>Operating Range</i> ♦		The range of distances between the <i>Range Min</i> and <i>Range Max</i> , between which the sensor will detect a target. Targets closer than Range Min may still be detected (at incorrect distance) due to multiple reflections.	♦
Parameters that Affect Measurements			
These parameters are available by clicking the SenixVIEW MEASURE icon.			
<i>Measurement Interval</i> (p 34)	►	The period between measurements. Values can range from 5 ms to 1.275 sec at 5 ms resolution. ► TEACH 24-28 are used to select specific measurement intervals	See page 8
<i>Temperature Compensation</i> (p 41)	►	Temperature compensation can be turned ON or OFF. ► TEACH 32 = Enabled, TEACH 33 = Disabled (Last used mode reinstated, or default Contant PWR mode)	Disabled
<i>Filters</i> (p 38)	►	Filter options include Closest or Farthest of M, X of Y, Running or Boxcar average of N, Max Rate and Slow/Fast Rate ► TEACH 6 toggles the Slow-Fast filter on and off	All filters OFF
<i>Measurement Activation</i> (p31)	►	Continuous (at <i>measurement interval</i>) Start on Poll (Measure upon receiving serial data read poll) SYNC Master (continuous at <i>sync interval</i>) SYNC Slave 1, 2, 3, 4 or 5 (at <i>sync interval</i> , measures when receive associated SYNC input from SYNC Master) (<i>sync interval</i> = <i>measurement interval</i> x <i>SYNC phases</i>) ► TEACH 12,13,14 and 15 set activation modes	Continuous
<i>SYNC Phases</i>		The number of SYNC phases generated by a SYNC Master (pg. 33)	2 ♣

ToughSonic® Family Sensors – Installation & Operating Instructions

<i>No Sync Delay</i>	The time a SYNC Slave sensor must continuously fail to detect a SYNC input before setting the No SYNC switch state(s) or analog value(s). Values: 0 ms to 5.46 minutes (resolution 5 ms)	0 ms
<i>PowerSave</i>	PowerSave reduces average power consumption. Options: Enabled and Disabled .	Disabled
Security Parameter This parameter is toggled on and off by clicking the Teach icon.		
<i>TEACH Pushbutton (select models)</i>	The TEACH button can be disabled for security purposes. Options are Enabled and Disabled. TEACH is always enabled in a SYNC master or slave.	Enabled

	Parameters that Affect Switch Outputs (if selected) Setpoints are available on the SenixVIEW Main Screen. Other parameters are obtained by clicking the Switches icon.	
<i>Switch Output Selection</i>	ToughSonic 2, 12, and 14: One or two switch outputs may be optionally selected (see page 45). The factory default is none selected. When Switch #1 is selected it exists on the BLACK wire. When Switch #2 is selected it exists on the WHITE wire. Switches are configurable as sinking (NPN) or sourcing (PNP) type. If both are selected they are independently adjustable. ToughSonic 30, 50, and 50P: Two switches always available, no selection required.	♣

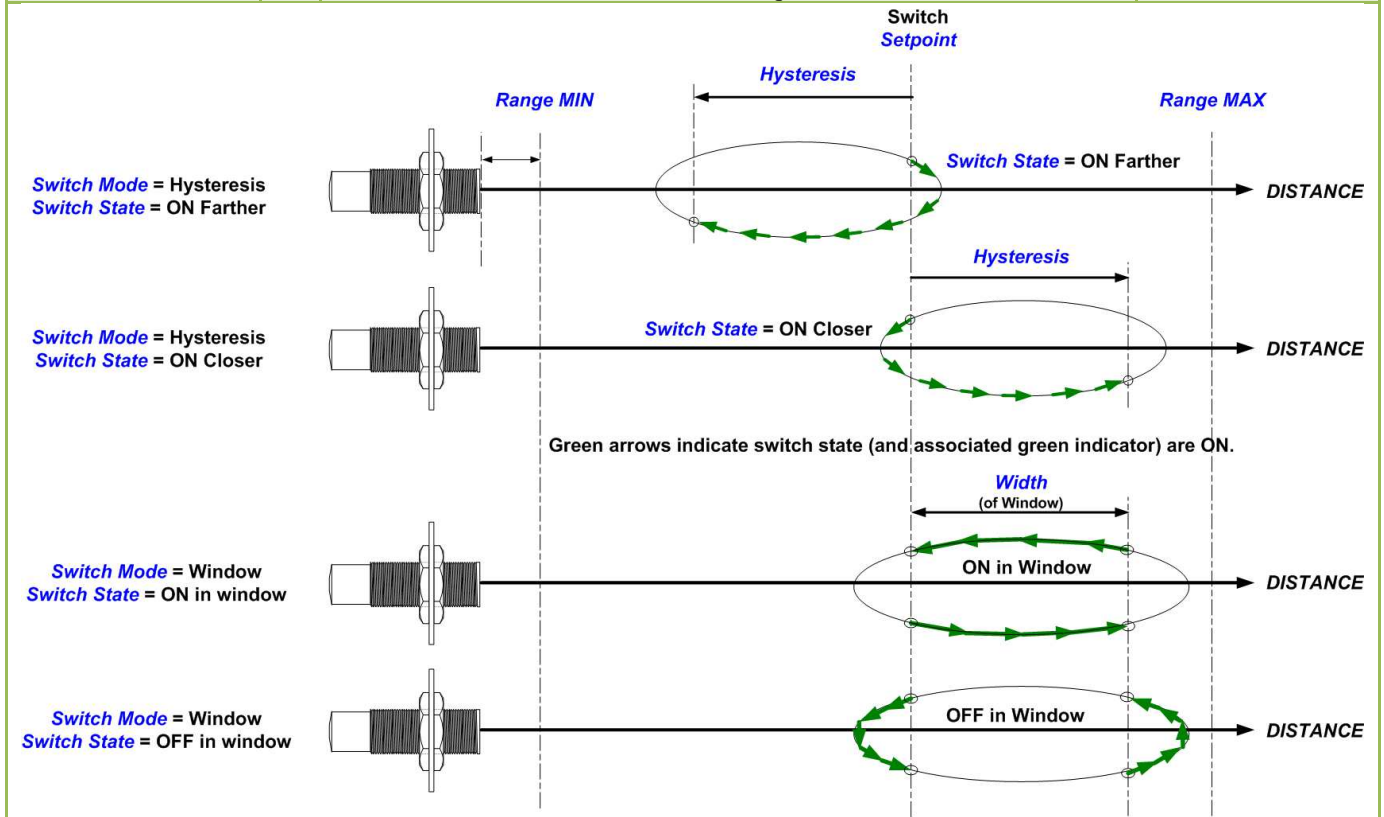

ToughSonic® Family Sensors – Installation & Operating Instructions

<i>Switch Mode</i>		<p>Hysteresis: Switch turns ON at the <i>Setpoint</i> and OFF after the distance reverses direction by at least <i>Hysteresis</i></p> <p>Window: The Switch State is set in a distance window beginning at <i>Window Near</i> and ending at <i>Window Far</i> from the sensor</p> <p>Options: Setpoint or Window</p>	SW #1:Setpoint SW #2:Setpoint
<i>Power-Up State</i>		<p>The switch state set when power is first applied. This state remains until completion of the first <i>Measurement Cycle</i> or <i>Measurement Process</i>.</p> <p>Options: ON and OFF</p>	SW #1: OFF SW #2: OFF
<i>Setpoint</i>	▶	<p>The distance where a switch changes from OFF to ON.</p> <p>(▶ TEACH 7 = SW#1, TEACH 9 = SW#2)</p>	See page 8
<i>Polarity</i>	▶	<p>If Switch Mode = Hyst: Direction of target through Setpoint causing ON</p> <p>Options: On Closer or On Farther</p> <p>If Switch Mode = Window: Switch state when target detected in window</p> <p>Options: ON or OFF</p> <p>(▶ TEACH 8 = toggle SW#1 state, TEACH 10 = toggle SW#2 state)</p>	SW #1: ON Closer SW #2: ON Farther
<i>No Target State</i>		<p>Switch action if no target is detected (TARGET LED = RED) for a time period exceeding the switch's No Target Delay.</p> <p>Options: ON, OFF and HOLD (no change)</p>	SW #1: OFF SW #2: OFF
<i>No Target Delay</i>	▶	<p>The minimum time the sensor must continuously fail to detect a target before setting the No Target State</p> <p>Values: 5 ms to 5.46 minutes (resolution 5 ms)</p> <p>(▶ TEACH 20 = 1 second, TEACH 21 = 0 ms [OFF])</p>	SW #1: 0 ms SW #2: 0 ms
<i>Hysteresis</i>		<p>The distance a target must change in the reverse direction of the ON state (Setpoint) to turn OFF (Setpoint Mode)</p> <p>Values: 0 to 221.77 in. (5.63 m)</p> <p>(Warning if result surpasses Range Window for selected Switch Mode)</p>	SW #1: 0.25 in. (6.4 mm) SW #2: 0.25 in. (6.4 mm)
<i>On Delay</i>		<p>The minimum time the sensor must continuously measure a distance representing an ON condition before setting the Switch State to ON</p> <p>Values: 0 ms to 5.46 minutes (resolution 5 ms)</p>	SW #1: 0 ms SW #2: 0 ms
<i>Off Delay</i>		<p>The minimum time the sensor must continuously measure a distance representing an OFF condition before setting the Switch State to OFF.</p> <p>Values: 0 ms to 5.46 minutes (resolution 5 ms)</p>	SW #1: 0 ms SW #2: 0 ms
<i>No Sync State</i>		<p>Switch state set by a SYNC Slave sensor with no master SYNC input (target indicator = red/green) for a period exceeding <i>No Sync Delay</i>.</p> <p>Options: ON, OFF and HOLD (no change)</p>	SW #1: OFF SW #2: OFF
<i>No Sync Delay</i>		<p>See description under <i>Parameters that Affect Measurements</i>. This parameter is shared by all analog and switch outputs.</p>	0 ms
<i>Window Far</i>		<p>The window distance farthest from the sensor for a switch in the <i>Window</i> mode.</p>	<i>Setpoint</i> + 0.25 inches
<i>Window Near</i>	▶	<p>The window distance closest to the sensor for a switch in the <i>Window</i> mode.</p> <p>(▶ TEACH 7 = SW#1, TEACH 9 = SW#2)</p> <p>NOTE: If <i>Window Near</i> is changed by TEACH the <i>Window Far</i> value will also change to maintain a constant window width.</p>	Same as <i>Setpoint</i>

Feature	Teach?	Description	As Shipped from Factory
		<p><i>Parameters that Affect Analog Outputs</i> <i>(if selected)</i></p> <p>Endpoints are available on the SenixVIEW Main Screen. Other parameters are obtained by clicking the Analog icon.</p>	
<i>Analog Selections</i>		<p>ToughSonic 3, 12, and 14: Each analog output may be optionally selected (see page 45). The factory default is both selected. When Current Loop is selected it exists on the BLACK wire. When Voltage is selected it exists on the WHITE wire.</p> <p>ToughSonic 30, 50, and 50P: V and I always available, no selection required.</p> <p>Note: The voltage and current share the same Analog Window, Analog Slope, No-Target Delay and No Sync Delay.</p>	Current Selected Voltage Selected ♣
<i>Analog Window</i> (analog shared) ◆		The range of distances between the Low Endpoint and High Endpoint , between which the voltage and current outputs are linearly scaled to change between their Low Values and High Values respectively.	Between the endpoints listed below
<i>Analog Slope</i> (analog shared) ◆		The analog slope increases or decreases with distance depending on the relative positions of the Low Value Endpoint and High Value Endpoint . The current and voltage must have the same slope. The voltage min and max values must be separated by at least 0.1 VDC. The current min and max values must be separated by at least 0.2 mA.	Increasing ◆
<i>Low Value Endpoint</i> (analog shared)	▶ 4	One end of the range of distances over which the analog outputs are scaled. At the Low Value Endpoint distance the outputs are the Voltage Low Value and/or Current Low Value . If this distance is outside the sensor's Operating Range the value will not be reached but the sensor operates properly for in-range targets.	See page 8
<i>High Value Endpoint</i> (analog shared)	▶ 5	One end of the range of distances over which the analog outputs are scaled. At the High Value Endpoint distance the outputs are the Voltage High Value and/or Current High Value . If this distance is outside the sensor's Operating Range the value will never be reached but the sensor operates properly for in-range targets.	See page 8

ToughSonic® Family Sensors – Installation & Operating Instructions

<i>Voltage High Value</i>	▶	Voltage output for targets detected at the <i>High Value Endpoint</i> (and outside the <i>High Value Endpoint</i> side of the analog range) Either the standard default 10 VDC or a custom value can be entered. Values: 0.1 to 10 VDC in 50 mV steps Value must be at least 1.0 volts above the <i>Voltage Low Value</i> . (▶ TEACH 30 sets this value to 5 VDC, TEACH 31 to 10 VDC)	10 VDC
<i>Voltage Low Value</i>	▶	Voltage output for targets detected at the <i>Low Value Endpoint</i> (and outside the <i>Low Value Endpoint</i> side of the analog range) Either the standard default 0 VDC or a custom value can be entered. Values: 0 VDC to 9.9 VDC in 50 mV steps Value must be at least 1.0 volts below the <i>Voltage High Value</i> . (▶ TEACH 30 or 31 sets this value to 0 VDC)	0 VDC
<i>Current High Value</i>		Current output for targets detected at the <i>High Value Endpoint</i> distance (and outside the <i>High Value Endpoint</i> side of the analog range) Either the standard default 20 mA or a custom value can be entered. Values: 2.2 to 20 mA in 0.1 mA steps Value must be at least 2.0 mA above the <i>Current Low Value</i> .	20 mA
<i>Current Low Value</i>		Current output for targets detected at the <i>Low Value Endpoint</i> distance (and outside the <i>Low Value Endpoint</i> side of the analog range) Either the standard default 4 mA or a custom value can be entered. Values: 2 mA to 19.9 mA in 0.1 mA steps Value must be at least 2.0 mA below the <i>Current High Value</i> .	4 mA
<i>Power-Up Voltage</i>		The voltage output value set when power is first applied; remains until completion of the first <i>Measurement Cycle</i> or <i>Measurement Process</i> . Options: LOW or HIGH analog output value Voltage goes to <i>Voltage Low Value</i> or <i>Voltage High Value</i> .	LOW
<i>Power-Up Current</i>		Current loop output value set when power is first applied; remains until completion of the first <i>Measurement Cycle</i> or <i>Measurement Process</i> . Options: LOW or HIGH analog output value Current goes to <i>Current Low Value</i> or <i>Current High Value</i> .	LOW
<i>No Target Voltage</i>		Voltage value if no target is detected (TARGET LED = RED) for a time period exceeding the analog <i>No Target Delay</i> . Options: LOW , HIGH , and HOLD (no change)	HOLD
<i>No Target Current</i>		Current loop output value if no target is detected (TARGET LED = RED) for a time period exceeding the analog <i>No Target Delay</i> . Options: LOW , HIGH , and HOLD (no change)	HOLD
<i>No-Target Delay (shared)</i>		The minimum time the sensor must continuously fail to detect a target before setting the No Target Value. Values: 0 ms to 5.46 minutes (resolution 5 ms)	0 ms
<i>No Sync Voltage</i>		Voltage value set by a SYNC Slave sensor with no master SYNC input (target indicator = red/green) for a period exceeding <i>No Sync Delay</i> . Options: LOW , HIGH , and HOLD (no change)	HOLD
<i>No Sync Current</i>		Current loop value set by a SYNC Slave with no master SYNC input (target indicator = red/green) for a period exceeding <i>No Sync Delay</i> . Options: LOW , HIGH , and HOLD (no change)	HOLD
<i>No Sync Delay</i>		See description under <i>Parameters that Affect Measurements</i> . This parameter is shared by all analog and switch outputs.	0 ms
<i>(analog shared)</i>		Indicates parameter applies to all current loop and voltage outputs.	